



ACTION

IMPACT SOCKETS FOR OPTIMAL PERFORMANCE AND SAFETY

www.rami-yokota.com



ENGLISH

Impact sockets
Sleeve drive sockets
Accessories

DEUTSCH

Kraftsteckschlüssel
Spindelgeführte
Steckschlüssel
Zubehör

FRANÇAIS

Douilles à choc
Douilles guidées
Accessoires



	ABOUT ACTION	ÜBER ACTION	A PROPOS D'ACTION	PAGE SEITE PAGE
	INTRODUCTION	Einleitung	A propos d'ACTION	4
	IMPACT SOCKETS FOR SCREWDRIVERS	KRAFTSTECKSCHLÜSSEL FÜR DREHSCHRAUBER	DOUILLES À CHOC POUR VISSEUSES	
1/4"	6-POINT & TAP HOLD SOCKETS	6-Kant & Gewindebohrerhalter	6-pans douille porte-taraud	6
	IMPACT SOCKETS	KRAFTSTECKSCHLÜSSEL	DOUILLES À CHOC	
1/4"	6-POINT NORMAL	6-Kant normale Länge	6-Pans normales	7
	6-POINT DEEP	6-Kant tiefe Ausführung	6-pans profonde	7
	TORX®	Torx®	Torx®	8
	SURFACE DRIVE	Surface Drive	Surface Drive	9
	UNIVERSAL JOINT SOCKETS	Kugelgelenkschlüssel	Cardan 6-pans	9
3/8"	6-POINT NORMAL	6-Kant normale Länge	6-Pans normales	10
	6-POINT DEEP	6-Kant tiefe Ausführung	6-Pans profonde	10
	12-POINT NORMAL	12-Kant normale Länge	12-Pans normales	11
	12-POINT DEEP	12-Kant tiefe Ausführung	12-Pans profonde	11
	SURFACE DRIVE	Surface Drive	Surface Drive	12
	TORX®	Torx®	Torx®	13
	TRIPLE SQUARE	Außen-6-Kant (Inbus) AußenXZN	Empreinte 6-Pans Carré triple	15
	TAP HOLDING SOCKETS	Gewindebohrerhalter	Douille porte-taraud	15
	UNIVERSAL JOINTS	Kugelgelenkschlüssel	Cardan	15
	HEX DRIVER-6-POINT (INBUS)	Außen-6-Kant (Inbus)	Empreinte 6-pans	16
RIBE DRIVER	RIBE Profil	Profil Ribe	16	
1/2"	4-POINT / DOUBLE SQUARE	4-Kant Doppel-4-Kant	4-Pans Douille octagonal	16
	6-POINT NORMAL	6-Kant normale Länge	6-Pans normales	18
	6-POINT DEEP	6-Kant tiefe Ausführung	6-Pans profonde	18
	12-POINT NORMAL	12-Kant normale Länge	12-Pans normales	21
	12-POINT DEEP	12-Kant tiefe Ausführung	12-Pans profonde	21
	SURFACE DRIVE	Surface Drive	Surface Drive	22
	TORX®	Torx®	Torx®	22
	UNIVERSAL JOINTS	Kugelgelenkschlüssel	Cardan	24
	TRIPLE SQUARE	Außen-6-Kant (Inbus) Außen XZN	Empreinte 6-Pans Carré triple	25
	RIBE DRIVER	RIBE Profil	Profil Ribe	25
	TAP HOLDING SOCKETS	Gewindebohrerhalter	Douille porte-taraud	25
	STUD BOLT SETTERS	Stehbolzensetzer	Prise goujon	26
	3/4"	4-POINT	4-Kant	4-Pans
6-POINT NORMAL		6-Kant normale Länge	6-Pans normales	27
6-POINT DEEP		6-Kant tiefe Ausführung	6-Pans profonde	28
STUD BOLT SETTERS		Stehbolzensetzer	Prise goujon	27
8-POINT		8-Kant normale Länge	8-Pans normales	29
12-POINT NORMAL		12-Kant normale Länge	12-Pans normales	29
12-POINT DEEP		12-Kant tiefe Ausführung	12-Pans profonde	30
TORX®		Torx®	Torx®	30

1"	4-POINT NORMAL	4-Kant normale Länge	4-Pans normales	32
	6-POINT NORMAL	6-Kant normale Länge	6-Pans normales	32
	6-POINT DEEP	6-Kant tiefe Ausführung	6-pans profonde	33
	8-POINT NORMAL	8-Kant normale Länge	8-Pans normales	34
	12-POINT NORMAL	12-Kant normale Länge	12-Pans normales	34
	12-POINT DEEP	12-Kant tiefe Ausführung	12-Pans profonde	35
	HEX DRIVER-6-POINT (INBUS)	Außen-6-Kant (Inbus)	Empreinte 6-pans	35
1½"	6-POINT NORMAL	6-Kant normale Länge	6-Pans normales	36
	6-POINT DEEP	6-Kant tiefe Ausführung	6-pans profonde	36
	HEX DRIVER 6-POINT (INBUS)	Außen-6-Kant (Inbus)	Empreinte 6-pans	37
2½"	6-POINT NORMAL	6-Kant normale Länge	6-Pans normales	37
	EXTENSIONS	VERBINDUNGSTEILE	ADAPTATEURS	
	EXTENSION BARS	Verlängerungen	Rallonges	38
	LOCK PIN RETAINER	Adapter Schnellwechselfutter	Mandrin à chocs	38
	UNIVERSAL JOINTS	Kugelgelenke	Rallonges wobble	39
	IMPACT BIT HOLDER	Verbindungsteil mit Außenvierkant	Cardans	39
	ADAPTORS	Reduzierstücke	Adaptateurs	40
	QUICK-CHANGE ADAPTORS	Schnellwechselhalter	Mandrin à chocs	40
	SLEEVE DRIVE SOCKETS	SPINDELGEFÜHRTE STECKSCHLÜSSEL	DOUILLES GUIDÉES	
3/8"	6-POINT NORMAL	6-Kant normale Länge	6-Pans normales	44
	6-POINT LONG	6-Kant lang	6-Pans longues	44
	6-POINT DEEP	6-Kant tiefe Ausführung	6-Pans profonde	45
	TORX®	Torx®	Torx®	45
	HEX DRIVER (INBUS)	Außen-6-Kant (Inbus) AußenXZN	Empreinte 6-Pans Carré triple	45
1/2"	6-POINT NORMAL	6-Kant normale Länge	6-Pans normales	46
	6-POINT LONG	6-Kant lang	6-Pans longues	46
	6-POINT DEEP	6-Kant tiefe Ausführung	6-Pans profonde	47
	TORX®	Torx®	Torx®	47
	HEX DRIVER (INBUS)	Außen-6-Kant (Inbus) AußenXZN	Empreinte 6-Pans Carré triple	47
STUD BOLT SETTERS	Stehbolzensetzer	Prise goujon	47	
3/4"	6-POINT NORMAL	6-Kant normale Länge	6-Pans normales	48
	HEX DRIVER (INBUS)	Außen-6-Kant (Inbus) Außen XZN	Empreinte 6-Pans Carré triple	48
	TORX®	Torx®	Torx®	48
	EXTENSIONS	Verlängerungen	Rallonges	48
	QUICKCHANGE ADATORS	Schnellwechselhalter	Rallonges	49
ADAPTORS	Verbindungsteile	Adaptateurs	49	
	IMPACT SOCKETS SETS	KRAFTSTECKSCHLÜSSELSETS	JEU DE DOUILLES À CHOC	
	IMPACT SOCKETS SETS	Kraftsteckschlüsselsets	Jeu de douilles pour boulon	50
	TORQUE SOCKETS	Torsionskraftsteckschlüssel	Barres limiteur de couple	54



SQUARE DRIVE

ACTION impact sockets are available for Square Drives of 1/4" up to 2 1/2". The shape of the square drive of these sockets are characterized by corners that are rounded off, so the square drive of the powertool have the best possible fit. This means that the torque is transmitted on a large area, not only on the corners of the socket. This results in good endurance of the sockets and a long lifetime.



6 POINT SOCKETS

The 6-point sockets manufactured by ACTION also have rounded off corners. The rounded corners allow some space for the points of the bolthead, so the torque is transmitted on the flanks of the bolthead, giving you better results. Driving the flanks also means that the wear on the points of the bolthead or nut is reduced. For 12-points sockets, a similar geometry is used.



SURFACE DRIVE SOCKETS

Surface Drive Sockets are designed to drive only the center of the flank of a bolthead or nut. The Surface Drive sockets should be recommended for use on nuts with points that have worn off, but also for nuts of softer materials and polished nuts and boltheads.



SLEEVE DRIVE SOCKETS

Sleeve Drive Sockets have been developed by ACTION at the request of YOKOTA to improve the quality of a joint tightened with impulse wrenches. Sleeve Drive Sockets minimize play between socket and tool thus reducing "wobble" and stabilizing the torque setting. The use of Sleeve Drive Sockets is not only of benefit to the actual joint but also reduces vibration to the tool and operator, and reduces noise levels and tool wear.



CAUTION!

Always wear safety goggles when using impact equipment. Do not hold the socket while in use.

All ACTION impact sockets are manufactured according to DIN 3121 and DIN 3129.

Universal joints, reducing adapters and thin wall sockets are supplied without warranty.

European Regulation, Directive of Machinery 2006/42/EG and EN/ISO 11148-6, states that only impact sockets are to be used on power tools.

→ If you can't find the proper dimensions, type or size in this catalogue, please contact us!

VIERKANTANTRIEB

ACTION Kraftsteckschlüssel sind lieferbar für Vierkanttrieb von ¼" bis 2½". Die Form des Vierkanttriebs dieser Kraftsteckschlüssel ist in den Ecken nach außen abgerundet, wodurch der Antriebsvierkant des Schlagschraubers ausgezeichnet passt. Das bedeutet, dass das Drehmoment weitestgehend übertragen wird, nicht nur in den Ecken des Kraftsteckschlüssels. Hierdurch leben Ihre Kraftsteckschlüssel und Schlagschrauber länger.

SECHSKANTKRAFTSTECKSCHLÜSSEL

Die von ACTION hergestellten Sechskantkraftsteckschlüssel haben auch abgerundete Ecken. Die abgerundeten Innenecken der Kraftsteckschlüssel haben ein gewisses Spiel in den Ecken des Sechskants des Schraubkopfes, was zu besseren Ergebnissen führt. Der Flankentrieb bedeutet auch, dass der Verschleiß der Schraubkopf- oder Mutterecken reduziert wird. Für die Zwölfkantkraftsteckschlüssel gilt Ähnliches.

SURFACE DRIVE-STECKSCHLÜSSEL

Surface Drive-Steckschlüssel sind entwickelt, um nur die Mitte der Flanken der Schraube oder Mutter anzutreiben. Die Surface Drive-Steckschlüssel werden empfohlen für die Verwendung von Nüssen mit abgenutzten Ecken, aber auch bei Nüssen aus weicherem Material bzw. polierten Nüssen und Schrauben.

SPINDELGEFÜHRTE KRAFTSTECKSCHLÜSSEL

Steckschlüssel mit Spindelführung wurden auf Wunsch von YOKOTA durch ACTION entwickelt, um die Qualität der Schraubverbindung mit Impulsschraubern zu verbessern. Spindelgeführte Steckschlüssel haben ein minimales Spiel zwischen Steckschlüssel und Antriebsspindel. Dadurch wird das "Wackeln" reduziert und die Drehmomentverluste werden geringer. Der Einsatz von spindelgeführten Steckschlüsseln bietet nicht nur Vorteile für den Schraubfall, sondern reduziert auch den Geräuschpegel und Verschleiß sowie die Vibration der Maschine für den Anwender.

VORSICHT!

Tragen Sie immer eine Sicherheitsbrille bei der Verwendung von Kraftsteckwerkzeug und -geräten. Halten Sie keinen Kraftsteckschlüssel fest, wenn die Maschine in Betrieb ist.

Alle ACTION Kraftsteckschlüssel sind gemäß DIN 3121 und DIN 3129 hergestellt.

Alle Kugelgelenke und dünnwandigen Kraftsteckschlüssel werden ohne Garantie geliefert.

Richtlinie für Maschinen 2006/42/EG und EN/ISO 11148-6 besagt, dass nur Kraftsteckschlüsseinsätze auf Schlagschraubern eingesetzt werden sollen.

→ Sollten Sie die richtigen Typen oder Abmessungen bzw. Schlüsselweiten in diesem Katalog nicht finden, bitte sprechen Sie uns hierzu an!

CARRÉ D'ENTRAÎNEMENT

Les douilles impact ACTION sont disponibles avec des carrés d'entraînement de taille 1/4" jusque 2 1/2". La forme du carré d'entraînement de ces douilles est caractérisée par les coins arrondis, ainsi le carré d'entraînement de la visseuse a le meilleur positionnement possible. Ceci entraîne un couple de serrage transmis sur une large surface et non seulement dans les coins de la douille. Il résulte ainsi une bonne endurance des douilles et une longue durée de vie.

DOUILLES 6-PANS

Les douilles 6-Pans fabriquées par ACTION ont aussi des coins arrondis. Les coins arrondis permettent de l'espace pour la tête de vis 6-pans, ainsi le couple de serrage est transmis sur les flancs de la tête de vis, donnant de meilleurs résultats. L'entraînement des flancs signifie aussi que l'usure des flancs sur les pans de la tête de vis ou du boulon est réduite. Pour les douilles 12-Pans une géométrie similaire est utilisée.

DOUILLES SURFACE DRIVE

Les douilles Surface Drive sont conçues pour entraîner seulement le centre des flancs de la tête de vis ou du boulon. Les douilles Surface Drive doivent être recommandées pour une utilisation avec des boulons à pans usés, mais aussi pour des boulons avec des matériaux plus tendres et des têtes de vis ou boulons polis.

DOUILLES GUIDÉES (SLEEVE DRIVE)

Les douilles Sleeve Drive ont été développées par ACTION à la demande de YOKOTA pour améliorer la qualité d'un assemblage vissé avec des visseuses à impulsions. Les douilles Sleeve Drive minimise le jeu entre la douille et la visseuse réduisant ainsi l'oscillation et stabilisant le couple réglé. L'utilisation des douilles Sleeve Drive améliore la qualité d'assemblage et réduit aussi la vibration dans la visseuse et dans la main de l'opérateur. On note également une réduction du bruit et de l'usure de l'outil. Des douilles usées sont la cause de perte de puissance, usure du carré d'entraînement de l'outil et augmentation des vibrations et bruits pour l'opérateur. Remplacer vos douilles usées à temps.

ATTENTION!

Toujours porter des lunettes de sécurité en utilisant des outils à chocs. Ne pas tenir la douille pendant l'utilisation. Toutes les douilles à chocs

Action sont usinées selon les normes DIN 3121 et DIN 3129.

Les douilles à cardan et à paroi mince sont fournies sans garantie.

La réglementation européenne, Directive des machines 2006/42/EG et EN/ISO 11148-6, statue que seules les douilles à chocs sont à utiliser avec des visseuses motorisées.

→ Si vous ne pouvez trouver les dimensions, type et tailles requises pour votre application dans ce catalogue, contactez nous!

IMPACT SOCKETS FOR SCREWDRIVERS

KRAFTSTECKSCHLÜSSEL FÜR DREHSCHRAUBER

DOUILLES À CHOC POUR VISSEUSES



IMPACT SOCKETS | KRAFTSTECKSCHLÜSSEL | DOUILLES À CHOC



1/4" DRIVE | ANTRIEB | CARRÉ D'ENTRAÎNEMENT

6-POINT NORMAL 1

6-Kant normal
6-Pans normale

Type	IMG	D1 mm	L mm	L1 mm	-	
Metrical · Metrisch · Metriques						
DO697B0S04	4	A	8	55	4,5	-
DO697B0S06	6	A	10	55	4,5	-
DO697B0T06	6	A	10	75	4,5	-
DO697B0T07	7	A	11	75	4,5	-
DO697B0T08	8	A	12	75	4,5	-
DO697B0T10	10	A	14	75	5,5	-
DO697B0T12	12	A	17	75	5,5	-
DO697B0T13	13	A	18	75	5,5	-
DO697B0T14	14	A	19	75	5,5	-
DO697B0W12	12	A	17	200	5,5	-
DO697B0W14	14	A	19	200	5,5	-

6-POINT MAGNETIC 2

6-Kant magnetisch
6-Pans magnétique

Type	IMG	D1 mm	L mm	L1 mm	-	
Metrical · Metrisch · Metriques						
DO697B0M06	6	B	10	55	4,5	-
DO697B0M07	7	B	11	55	4,5	-
DO697B0M08	8	B	12	55	4,5	-
DO697B0M10	10	B	14	55	5,5	-
DO697B0M11	11	B	16	55	5,5	-
DO697B0M12	12	B	17	55	5,5	-
DO697B0M13	13	B	18	55	5,5	-
DO697B0M14	14	B	19	55	5,5	-
DO697B0N10	10	B	14	75	5,5	-
DO697B0N12	12	B	17	75	5,5	-
DO697B0P06	6	B	10	100	4,5	-
DO697B0P07	7	B	11	100	4,5	-
DO697B0P08	8	B	12	100	4,5	-
DO697B0P10	10	B	14	100	5,5	-
DO697B0P12	12	B	17	100	5,5	-
DO697B0P13	13	B	18	100	5,5	-
DO697B0P14	14	B	19	100	5,5	-
DO697B0P17	17	B	23	100	5,5	-
DO697B0Q10	10	B	14	150	5,5	-

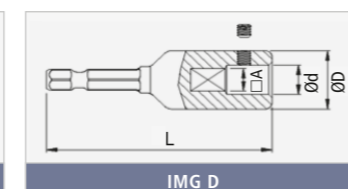
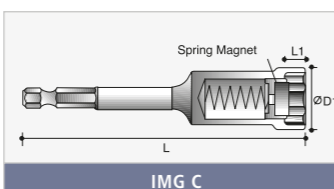
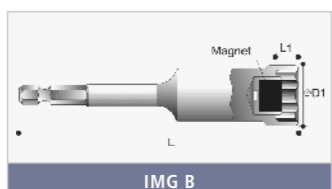
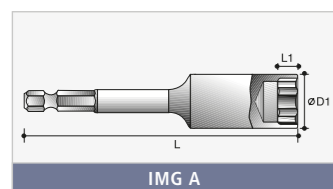

1/4" DRIVE | ANTRIEB | CARRÉ D'ENTRAÎNEMENT

6-POINT NORMAL 1

6-Kant normale Länge
6-Pans normales

Type	IMG	D1 mm	D2 mm	L mm	L2 mm	
Metrical · Metrisch · Metriques						
DO0014-0-004	4	A	7,6	13	23	4
DO0014-0-0045	4,5	A	8,2	13	23	5
DO0014-0-005	5	A	8,8	13	23	5
DO0014-0-0055	5,5	A	9,5	13	23	5
DO0014-0-006	6	A	10	13	23	6
DO0014-0-007	7	A	11,3	13	23	6
DO0014-0-008	8	A	12,5	13	23	7
DO0014-0-009	9	A	13,8	13	23	7
DO0014-0-010	10	C	15	13	23	7
DO0014-0-011	11	C	16,3	13	23	8
DO0014-0-012	12	C	17	13	23	8
DO0014-0-013	13	C	18,8	13	23	8
DO0014-0-014	14	C	20	13	23	8
DO0014-0-015	15	C	21	13	23	8

6-POINT 1

6-Kant normal
6-Pans normale

Type	IMG	D1 mm	D2 mm	L mm	L2 mm	
SAE · Zoll · Pouce						
DO0014-0-3/16	3/16"	A	8,5	13	23	5
DO0014-0-1/4	1/4"	A	10,3	13	23	6
DO0014-0-5/16	5/16"	A	12,5	13	23	7
DO0014-0-3/8	3/8"	C	15	13	23	7
DO0014-0-7/16	7/16"	C	16,3	13	23	8
DO0014-0-1/2	1/2"	C	18,8	13	23	8

6-POINT DEEP 2

6-Kant tief
6-Pans profunde

Type	IMG	D1 mm	D2 mm	L mm	L2 mm	
Metrical · Metrisch · Metriques						
DO0014-1-004	4	A	7,6	13	50	4
DO0014-1-045	4,5	A	8,2	13	50	6
DO0014-1-005	5	A	8,8	13	50	6
DO0014-1-006	6	A	10	13	50	7
DO0014-1-007	7	A	11,3	13	50	7
DO0014-1-008	8	A	12,5	13	50	9
DO0014-1-009	9	C	13,8	13	50	9
DO0014-1-010	10	C	15	13	50	9
DO0014-1-011	11	C	16,3	13	50	9
DO0014-1-012	12	C	17	13	50	9
DO0014-1-013	13	C	18,8	13	50	9
DO0014-1-014	14	C	20	13	50	9
DO0014-1-015	15	C	21	13	50	9

1/4" DRIVE | ANTRIEB | CARRÉ D'ENTRAÎNEMENT

6-POINT NORMAL MAGNETIC 3

6-Kant normal magnetisch
6-Pans normale magnétique

Type	IMG	D1 mm	D2 mm	L mm	L2 mm	
Metrical · Metrisch · Metriques						
DO6050P050	5	A	8,8	13	23	3
DO6050P055	5,5	A	9,5	13	23	3
DO6050P060	6	A	10	13	23	3
DO6050P070	7	A	11,3	13	23	3
DO6050P080	8	A	12,5	13	23	3
DO6050P090	9	C	13,8	13	23	4
DO6050P100	10	C	15	13	23	4
DO6050P110	11	C	16,3	13	23	5
DO6050P120	12	C	17	13	23	5
DO6050P130	13	C	18,8	13	23	5
DO6050P140	14	C	20	13	23	6
DO6050P150	15	C	21	13	23	6

6-POINT DEEP MAGNETIC 4

6-Kant tief magnetisch
6-Pans profunde magnétique

Type	IMG	D1 mm	D2 mm	L mm	L2 mm	
Metrical · Metrisch · Metriques						
DO6050R050	5	A	8,8	13	50	3
DO6050R055	5,5	A	9,5	13	50	3
DO6050R060	6	A	10	13	50	3
DO6050R070	7	A	11,3	13	50	3
DO6050R080	8	A	12,5	13	50	3
DO6050R090	9	C	13,8	13	50	4
DO6050R100	10	C	15	13	50	4
DO6050R110	11	C	16,3	13	50	5
DO6050R120	12	C	17	13	50	5
DO6050R130	13	C	18,8	13	50	5
DO6050R140	14	C	20	13	50	6
DO6050R150	15	C	21	13	50	6

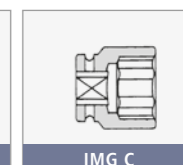
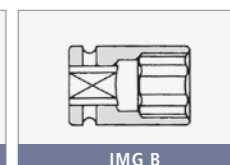
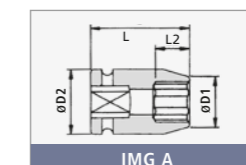



1/4" DRIVE | ANTRIEB | CARRÉ D'ENTRAÎNEMENT

HEX DRIVER 6-POINT (INBUS) 1

Außen-6-Kant (Inbus)
Empreinte 6-pans (inbus)

Type	mm	IMG	D2 mm	L mm	L1 mm	-
Metrical · Metrisch · Métriques						
DO64805025	2,5	D	13	35	4	-
DO64805030	3	D	13	35	6	-
DO64805040	4	D	13	35	6	-
DO64805050	5	D	13	35	6	-
DO64805060	6	D	13	35	8	-
DO64805070	7	D	13	35	8	-
DO64805080	8	D	13	35	8	-
DO64805090	9	D	13	35	10	-
DO64805100	10	D	13	35	10	-

TORX® INTERNAL 2

Torx® intern
Torx® intérieure

Type	mm	IMG	D2 mm	L mm	L1 mm	-
DO64701005	T5	F	13	2	35	-
DO64701006	T6	F	13	2	35	-
DO64701007	T7	F	13	2	35	-
DO64701008	T8	F	13	2	35	-
DO64701009	T9	F	13	2	35	-
DO64701010	T10	F	13	2,8	35	-
DO64701015	T15	F	13	2,8	35	-
DO64701020	T20	F	13	2,8	35	-
DO64701025	T25	F	13	3	35	-
DO64701027	T27	F	13	3	35	-
DO64701030	T30	F	13	3,8	35	-

Torx® is a trademark of Textron.

TORX® TAMPER RESISTANT INTERNAL 2

Torx® Tamper Resistant intern
Torx® Tamper Resistant intérieure

Type	mm	IMG	D2 mm	L mm	L1 mm	-
DO64706008	T8	F	13	2,0	35	-
DO64706009	T9	F	13	2,0	35	-
DO64706010	T10	F	13	2,8	35	-
DO64706015	T15	F	13	2,8	35	-
DO64706020	T20	F	13	2,8	35	-
DO64706025	T25	F	13	3,0	35	-
DO64706027	T27	F	13	3,0	35	-
DO64706030	T30	F	13	3,8	35	-

Torx® is a trademark of Textron.

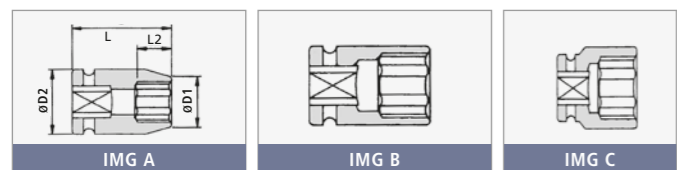

TORX® EXTERNAL 3

Torx® extern
Torx® extérieure

Type	mm	IMG	D1 mm	D2 mm	L mm	L2 mm
DO63300004	E4	A	7,2	13	25	4
DO63300005	E5	A	8	13	25	4,5
DO63300006	E6	A	9	13	25	5
DO63300007	E7	A	9,5	13	25	6
DO63300008	E8	A	10	13	25	6
DO63300010	E10	A	12,5	13	25	7,5
DO63300011	E11	B	13	13	25	8
DO63300012	E12	B	14,5	14,5	25	8,5

Torx® is a trademark of Textron.

TORX® THIN WALL EXTERNAL 4

Torx® dünnwandig extern
Torx® à paroi mince extérieure

Type	mm	IMG	D1 mm	D2 mm	L mm	L2 mm
DO63305004	E4	A	6,5	13	25	4
DO63305005	E5	A	7,5	13	25	4,5
DO63305006	E6	A	8,5	13	25	5
DO63305007	E7	A	9	13	25	6
DO63305008	E8	A	9,8	13	25	6
DO63305010	E10	A	12	13	25	6,5
DO63305011	E11	A	12,7	13	25	8
DO63305012	E12	A	14	14,5	25	8,5

Thin wall sockets are not covered by the Action warranty.
Torx® is a trademark of Textron.

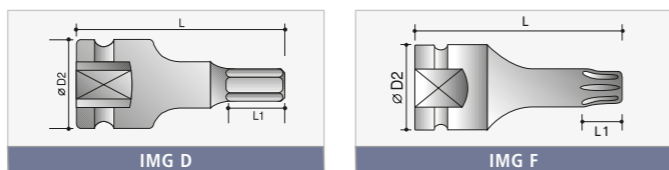

1/4" DRIVE | ANTRIEB | CARRÉ D'ENTRAÎNEMENT

SURFACE DRIVE NORMAL 1

Surface Drive - normal
Surface Drive normale

Type	mm	IMG	D1 mm	D2 mm	L mm	L2 mm
Metrical · Metrisch · Métriques						
DO63405040	4	A	7,6	13	23	4
DO63405045	4,5	A	8,2	13	23	5
DO63405050	5	A	8,8	13	23	5
DO63405055	5,5	A	9,5	13	23	5
DO63405060	6	A	10	13	23	6
DO63405070	7	A	11,3	13	23	6
DO63405080	8	A	12,5	13	23	7
DO63405090	9	C	13,8	13	23	7
DO63405100	10	C	15	13	23	7
DO63405110	11	C	16,3	13	23	8
DO63405120	12	C	17	13	23	8
DO63405130	13	C	18,8	13	23	8
DO63405140	14	C	20	13	23	8
DO63405150	15	C	21	13	23	8

SURFACE DRIVE DEEP 2

Surface Drive tief
Surface Drive profonde

Type	mm	IMG	D1 mm	D2 mm	L mm	L2 mm
Metrical · Metrisch · Métriques						
DO63407040	4	A	7,6	13	50	4
DO63407045	4,5	A	8,2	13	50	6
DO63407050	5	A	8,8	13	50	6
DO63407055	5,5	A	9,5	13	50	6
DO63407060	6	A	10	13	50	7
DO63407070	7	A	11,3	13	50	7
DO63407080	8	A	12,5	13	50	9
DO63407090	9	C	13,8	13	50	9
DO63407100	10	C	15	13	50	9
DO63407110	11	C	16,3	13	50	9
DO63407120	12	C	17	13	50	9
DO63407130	13	C	18,8	13	50	9
DO63407140	14	C	20	13	50	9
DO63407150	15	C	21	13	50	9

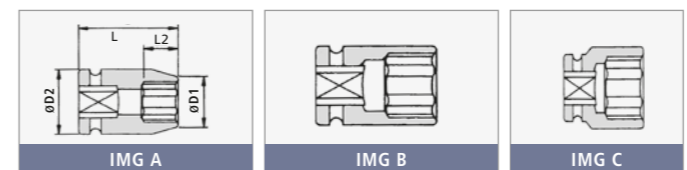

UNIVERSAL JOINT SOCKETS 6-POINT NORMAL 3

Kugelgelenkschlüssel 6-Kant
Cardan 6-pans normale

Type	mm	IMG	D1 mm	D2 mm	L mm	L2 mm
Metrical · Metrisch · Métriques						
DO62500050	5	E	8,8	15	43	5
DO62500055	5,5	E	9,5	15	43	6
DO62500060	6	E	10	15	43	6
DO62500070	7	E	11,5	15	43	8
DO62500080	8	E	12,5	15	43	8
DO62500090	9	E	14	15	43	8
DO62500100	10	E	15	15	43	8
DO62500110	11	E	16,5	15	43	8
DO62500120	12	E	16,8	16	48	8
DO62500130	13	E	18,8	16	48	8
DO62500140	14	E	19,8	16	48	8
DO62500150	15	E	20,8	16	48	8

Universal joints are not covered by the ACTION warranty.

PIN AND RING

Ring und Stift
Joint torique clavette

DO1014-0-000





3/8" DRIVE | ANTRIEB | CARRÉ D'ENTRAÎNEMENT

6-POINT NORMAL 1
6-Kant normal
6-Pans normale

Type	IMG	D1 mm	D2 mm	L mm	L2 mm
Metrical · Metrisch · Métriques					
DO1038-0-006	6 A	11	19	30	4
DO1038-0-007	7 A	12,5	19	30	8
DO1038-0-008	8 A	14	19	30	8
DO1038-0-009	9 A	15	19	30	8
DO1038-0-010	10 A	16	19	30	8
DO1038-0-011	11 A	17,5	19	30	9
DO1038-0-012	12 B	19	19	30	9
DO1038-0-013	13 A	20	22	30	9
DO1038-0-014	14 A	21	22	30	9
DO1038-0-015	15 B	22	22	30	11
DO1038-0-016	16 C	24	22	30	11
DO1038-0-017	17 C	25	22	30	11
DO1038-0-018	18 C	26	22	30	11
DO1038-0-019	19 C	27,5	22	30	11
DO1038-0-020	20 C	28	22	30	12
DO1038-0-021	21 C	30	22	30	13
DO1038-0-022	22 C	32	23	30	13
DO1038-0-024	24 C	34	23	30	13

6-POINT NORMAL 2
6-Kant normal
6-Pans normale

Type	IMG	D1 mm	D2 mm	L mm	L2 mm	
SAE · Zoll · Pouse						
DO1038-0-5/16	5/16"	A	12,5	19	30	8
DO1038-0-3/8	3/8"	A	14,5	19	30	8
DO1038-0-7/16	7/16"	A	17	19	30	9
DO1038-0-1/2	1/2"	B	19	19	30	9
DO1038-0-9/16	9/16"	B	20	20	30	9
DO1038-0-5/8	5/8"	B	24	24	30	11
DO1038-0-11/16	11/16"	B	24	24	30	11
DO1038-0-3/4	3/4"	B	26	26	30	11
DO1038-0-13/16	13/16"	B	28	28	30	13
DO1038-0-7/8	7/8"	B	30	30	30	13
DO1038-0-15/16	15/16"	B	32	32	30	13

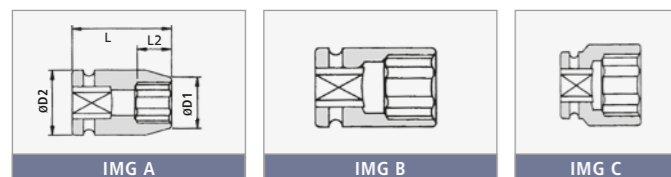

6-POINT NORMAL MAGNETIC 3
6-Kant normal magnetisch
6-Pans normale magnétique

Type	IMG	D1 mm	D2 mm	L mm	L2 mm
Metrical · Metrisch · Métriques					
DO6051P006	6 A	11,5	19	30	3
DO6051P007	7 A	12,5	19	30	3
DO6051P008	8 A	14	19	30	3
DO6051P009	9 A	15	19	30	4
DO6051P010	10 A	16,5	19	30	4
DO6051P011	11 A	17,5	19	30	5
DO6051P012	12 B	19	19	30	5
DO6051P013	13 A	20	22	30	5
DO6051P014	14 A	21,5	22	30	6
DO6051P015	15 B	22	22	30	6
DO6051P016	16 C	24	22	30	6
DO6051P017	17 C	25	22	30	6
DO6051P018	18 C	26	22	30	7
DO6051P019	19 C	27,5	22	30	7

6-POINT DEEP MAGNETIC 4
6-Kant tief magnetisch
6-Pans profonde magnétique

Type	IMG	D1 mm	D2 mm	L mm	L2 mm
Metrical · Metrisch · Métriques					
DO6051R006	6 A	11,5	19	55	3
DO6051R007	7 A	12,5	19	55	3
DO6051R008	8 A	14	19	55	3
DO6051R009	9 A	15	19	55	4
DO6051R010	10 A	16,5	19	55	4
DO6051R011	11 A	17,5	19	55	5
DO6051R012	12 B	19	19	55	5
DO6051R013	13 A	20	22	55	5
DO6051R014	14 A	21,5	22	55	6
DO6051R015	15 B	22	22	55	6
DO6051R016	16 C	24	22	55	6
DO6051R017	17 C	25	22	55	6
DO6051R018	18 C	26	22	55	7
DO6051R019	19 C	27,5	22	55	7

3/8" DRIVE | ANTRIEB | CARRÉ D'ENTRAÎNEMENT

6-POINT DEEP 1
6-Kant tief
6-Pans profonde

Type	IMG	D1 mm	D2 mm	L mm	L2 mm
Metrical · Metrisch · Métriques					
DO1038-1-007	7 A	12,5	19	63	12
DO1038-1-008	8 A	13,8	19	63	12
DO1038-1-009	9 A	15	19	65	12
DO1038-1-010	10 A	16	19	65	12
DO1038-1-011	11 A	17,5	19	65	25
DO1038-1-012	12 B	19	19	65	25
DO1038-1-013	13 A	20	22	65	25
DO1038-1-014	14 A	21	22	65	25
DO1038-1-015	15 B	22	22	65	25
DO1038-1-016	16 C	24	22	65	25
DO1038-1-017	17 C	25	22	65	25
DO1038-1-018	18 C	26	22	65	25
DO1038-1-019	19 C	27,5	22	65	25
DO1038-1-020	20 C	28	22	65	25
DO1038-1-021	21 C	30	22	65	25
DO1038-1-022	22 C	32	23	65	25

12-POINT NORMAL 2
12-Kant normal
12-Pans normale

Type	IMG	D1 mm	D2 mm	L mm	L2 mm
Metrical · Metrisch · Métriques					
DO65815006	6 A	11	19	30	5
DO65815007	7 A	12	19	30	5
DO65815008	8 A	13	19	30	6
DO65815009	9 A	15	19	30	6
DO65815010	10 A	16,5	19	30	7
DO65815011	11 A	17,5	19	30	8
DO65815012	12 A	19	20	30	9
DO65815013	13 A	20	22	30	9
DO65815014	14 A	21	22	32	11
DO65815015	15 B	22	22	32	11
DO65815016	16 C	24	22	32	11
DO65815017	17 C	25	22	32	12
DO65815018	18 C	26	22	34	13
DO65815019	19 C	27	22	34	13
DO65815020	20 C	28	22	34	13
DO65815021	21 C	30	22	34	15
DO65815022	22 C	31	23	34	15
DO65815023	23 C	32	23	34	15
DO65815024	24 C	34	23	34	16
DO65815025	25 C	35	23	36	16
DO65815026	26 C	36	23	36	16

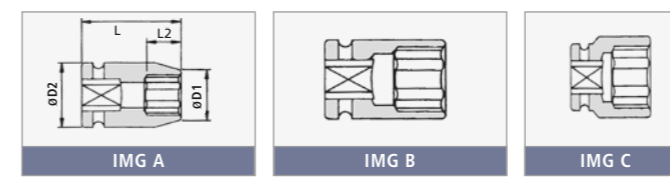

12-POINT DEEP 3
12-Kant tief
12-Pans profonde

Type	IMG	D1 mm	D2 mm	L mm	L2 mm
Metrical · Metrisch · Métriques					
DO65817006	6 A	11	19	63	5
DO65817007	7 A	12	19	63	5
DO65817008	8 A	13	19	63	6
DO65817009	9 A	15	19	65	6
DO65817010	10 A	16,5	19	65	7
DO65817011	11 A	17,5	19	65	8
DO65817012	12 A	19	20	65	9
DO65817013	13 A	20	22	65	9
DO65817014	14 A	21,5	22	65	11
DO65817015	15 B	22	22	65	11
DO65817016	16 C	24	22	65	11
DO65817017	17 C	25	22	65	11
DO65817018	18 C	26	22	65	13
DO65817019	19 C	27,5	22	65	13
DO65817020	20 C	28	22	65	13
DO65817021	21 C	30	22	65	15
DO65817022	22 C	32	23	65	15
DO65817023	23 C	33	23	65	15
DO65817024	24 C	34	23	65	16
DO65817025	25 C	35	23	65	16
DO65817026	26 C	36	23	65	16

STUD BOLT SETTERS

Stehbolzensetzer
Prise Goujon

Type	Size Gewinde Taille	D1 mm	D2 mm	L mm
DO69781050	M5x0,8	12	22	50
DO69781053	M6x1,0	12,5	22	50
DO69781056	M7x1,0	13	22	50
DO69781059	M8x1,0	15	22	50
DO69781060	M8x1,25	14,5	22	50
DO69781062	M10x1,25	18	22	50
DO69781063	M10x1,5	17	22	50
DO69781066	M12x1,75	19	22	50

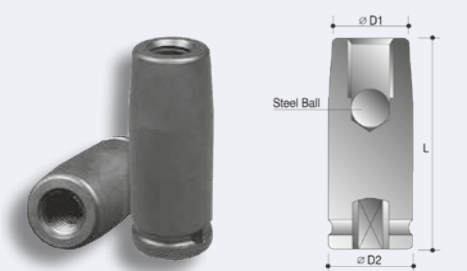



3/8" DRIVE | ANTRIEB | CARRÉ D'ENTRAÎNEMENT

6-POINT L=150 1
6-Kant L=150
6-Pans L=150

Type	IMG	D1 mm	D2 mm	L mm	L2 mm	
Metrical · Metrisch · Métriques						
DO60715006	6	G	11	19	150	4
DO60715008	8	G	13	19	150	8
DO60715010	10	G	16	19	150	8
DO60715012	12	G	18,5	19	150	9
DO60715013	13	G	20	22	150	9
DO60715014	14	G	21	22	150	9
DO60715015	15	G	22	22	150	11
DO60715016	16	G	24	22	150	11
DO60715017	17	G	25	22	150	11
DO60715018	18	G	26	22	150	12

6-POINT L=200 2
6-Kant L=200
6-Pans L=200

Type	IMG	D1 mm	D2 mm	L mm	L2 mm	
Metrical · Metrisch · Métriques						
DO60716006	6	G	11	19	200	4
DO60716008	8	G	13	19	200	8
DO60716010	10	G	16	19	200	8
DO60716012	12	G	18,5	19	200	9
DO60716013	13	G	20	22	200	9
DO60716014	14	G	21	22	200	9
DO60716015	15	G	22	22	200	11
DO60716016	16	G	24	22	200	11
DO60716017	17	G	25	22	200	11

6-POINT L=250 3
6-Kant L=250
6-Pans L=250

Type	IMG	D1 mm	D2 mm	L mm	L2 mm	
Metrical · Metrisch · Métriques						
DO60717006	6	G	11	19	250	4
DO60717008	8	G	13	19	250	8
DO60717010	10	G	16	19	250	8
DO60717012	12	G	18,5	19	250	9
DO60717013	13	G	20	22	250	9
DO60717014	14	G	21	22	250	9
DO60717015	15	G	22	22	250	11
DO60717016	16	G	24	22	250	11
DO60717017	17	G	25	22	250	11

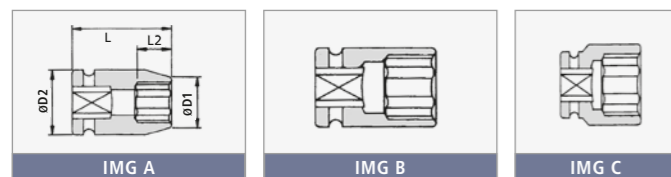

SURFACE DRIVE NORMAL 4
Surface Drive normal
Surface Drive normale

Type	IMG	D1 mm	D2 mm	L mm	L2 mm	
Metrical · Metrisch · Métriques						
DO63415008	8	A	13,8	19	32	8
DO63415009	9	A	15	19	32	8
DO63415010	10	A	16	19	32	8
DO63415011	11	A	17,5	19	32	9
DO63415012	12	B	19	19	32	9
DO63415013	13	A	20	22	32	9
DO63415014	14	B	22	22	32	9
DO63415015	15	B	22	22	32	11
DO63415016	16	C	24	22	32	11
DO63415017	17	C	25	22	32	11
DO63415018	18	C	26	22	32	11
DO63415019	19	C	28	22	32	11

SURFACE DRIVE NORMAL 4
Surface Drive normal
Surface Drive normale

Type	IMG	D1 mm	D2 mm	L mm	L2 mm	
SAE · Zoll · Pouce						
DO63410008	1/4"	A	11,5	19	32	4
DO63410010	5/16"	A	13,8	19	32	8
DO63410012	3/8"	A	15,5	19	32	8
DO63410014	7/16"	A	17,5	19	32	9
DO63410016	1/2"	A	20	22	32	9
DO63410018	9/16"	B	22	22	32	11
DO63410020	5/8"	C	24	22	32	11
DO63410022	11/16"	C	26	22	32	11
DO63410024	3/4"	C	28	22	32	11

SURFACE DRIVE DEEP 5
Surface Drive tief
Surface Drive profonde

Type	IMG	D1 mm	D2 mm	L mm	L2 mm	
SAE · Zoll · Pouce						
DO63412010	5/16"	A	13,8	19	80	12
DO63412012	3/8"	A	15,5	19	80	12
DO63412014	7/16"	A	17,5	19	80	25
DO63412016	1/2"	A	20	22	80	25
DO63412018	9/16"	B	22	22	80	25
DO63412020	5/8"	C	24	22	80	25
DO63412022	11/16"	C	26	22	80	25
DO63412024	3/4"	C	28	22	80	25

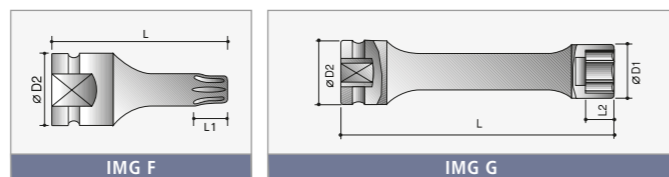

3/8" DRIVE | ANTRIEB | CARRÉ D'ENTRAÎNEMENT

SURFACE DRIVE DEEP 1
Surface Drive tief
Surface Drive profonde

Type	IMG	D1 mm	D2 mm	L mm	L2 mm	
Metrical · Metrisch · Métriques						
DO63417008	8	A	13,8	19	80	12
DO63417009	9	A	15	19	80	12
DO63417010	10	A	16	19	80	12
DO63417011	11	A	17,5	19	80	25
DO63417012	12	B	19	19	80	25
DO63417013	13	A	20	22	80	25
DO63417014	14	B	22	22	80	25
DO63417015	15	B	22	22	80	25
DO63417016	16	C	24	22	80	25
DO63417017	17	C	25	22	80	25
DO63417018	18	C	26	22	80	25
DO63417019	19	C	28	22	80	25

TORX® INTERNAL 2
Torx® intern
Torx® intérieure

Type	IMG	D2 mm	L1 mm	L mm	-	
DO64711009	T9	F	19	2,8	50	-
DO64711010	T10	F	19	2,8	50	-
DO64711015	T15	F	19	2,8	50	-
DO64711020	T20	F	19	3,0	50	-
DO64711025	T25	F	19	3,0	50	-
DO64711027	T27	F	19	3,8	50	-
DO64711030	T30	F	19	3,8	50	-
DO64711040	T40	F	19	4,3	50	-
DO64711045	T45	F	19	5,0	50	-
DO64711047	T47	F	19	5,0	50	-
DO64711050	T50	F	19	5,5	50	-

TORX® TAMPER RESISTANT INTERNAL 2
Torx® Tamper Resistant intern
Torx® Tamper Resistant intérieure

Type	IMG	D2 mm	L1 mm	L mm	-	
DO64716020	.T20	F	19	3,0	50	-
DO64716025	T25	F	19	3,0	50	-
DO64716027	T27	F	19	3,8	50	-
DO64716030	T30	F	19	3,8	50	-
DO64716040	T40	F	19	4,3	50	-
DO64716045	T45	F	19	5,0	50	-
DO64716047	T47	F	19	5,0	50	-
DO64716050	T50	F	19	5,5	50	-
DO64716055	T55	F	19	5,5	50	-

TORX® EXTERNAL 3
Torx® extern
Torx® extérieure

Type	IMG	D1 mm	D2 mm	L mm	L2 mm	
DO63310005	E5	A	9	19	32	4,5
DO63310006	E6	A	10	19	32	5
DO63310007	E7	A	10	19	32	6
DO63310008	E8	A	10,5	19	32	6
DO63310010	E10	A	12,5	19	32	7,5
DO63310011	E11	A	14,5	19	32	8
DO63310012	E12	A	15	19	32	8,5
DO63310014	E14	A	17,5	19	32	10
DO63310016	E16	B	19	19	32	11
DO63310018	E18	B	21	21	34	12,5

TORX® THIN WALL EXTERNAL 4
Torx® dünnwandig extern
Torx® à paroi mince extérieure

Type	IMG	D1 mm	D2 mm	L mm	L2 mm	
DO63315005	E5	A	8	19	32	4,5
DO63315006	E6	A	9	19	32	5
DO63315007	E7	A	9,3	19	32	6
DO63315008	E8	A	10	19	32	6
DO63315010	E10	A	12,3	19	32	7,5
DO63315011	E11	A	13	19	32	8
DO63315012	E12	A	14	19	32	8,5
DO63315014	E14	A	16,5	19	32	10
DO63315016	E16	A	18,4	19	32	11

Thin wall sockets are not covered by the Action warranty.
Torx® is a trademark of Texttron.

TORX® EXTERNAL MAGNETIC 5
Torx® extern magnetisch
Torx® extérieure magnétique

Type	IMG	D1 mm	D2 mm	L mm	L2 mm	
Metrical · Metrisch · Métriques						
DO6331N008	E8	A	11,5	19	32	5
DO6331N010	E10	A	13,5	19	32	5
DO6331N011	E11	A	14	19	32	5
DO6331N012	E12	A	15,5	19	32	6
DO6332N014	E14	A	17,5	19	32	8
DO6332N016	E16	A	19	19	32	9
DO6331N018	E18	A	21	20	32	9

Torx® is a trademark of Texttron.



3/8" DRIVE | ANTRIEB | CARRÉ D'ENTRAÎNEMENT

6-POINT THIN WALL NORMAL 1

6-Kant dünnwandig normal
6-Pans à paroi mince normales

Type	IMG	D1 mm	D2 mm	L mm	L2 mm
Metrical · Metrisch · Metriques					
DO61110006	6 A	10,5	19	30	4
DO61110007	7 A	11,5	19	30	8
DO61110008	8 A	12,5	19	30	8
DO61110009	9 A	14	19	30	8
DO61110010	10 A	15	19	30	8
DO61110011	11 A	17	19	30	9
DO61110012	12 A	17,5	19	30	9
DO61110013	13 B	19	19	30	9
DO61110014	14 B	20	20	30	9

Thin wall sockets are not covered by the ACTION warranty.

6-POINT THIN WALL DEEP 2

6-Kant dünnwandig tief
6-Pans à paroi mince profonde

Type	IMG	D1 mm	D2 mm	L mm	L2 mm
Metrical · Metrisch · Metriques					
DO61112007	7 A	11,5	19	65	12
DO61112008	8 A	12,5	19	65	12
DO61112009	9 A	14	19	65	12
DO61112010	10 A	15	19	65	25
DO61112011	11 A	17	19	65	25
DO61112012	12 A	17,5	19	65	25
DO61112013	13 B	19	19	65	25
DO61112014	14 B	20	20	65	25
DO61112015	15 A	21	22	65	25
DO61112016	16 C	22,5	22	65	25
DO61112017	17 C	24	22	65	25
DO61112018	18 C	25	22	65	25
DO61112019	19 C	26	22	65	25
DO61112020	20 C	27	22	65	25
DO61112021	21 C	28	22	65	25
DO61112022	22 C	30	23	65	25

Thin wall sockets are not covered by the ACTION warranty.

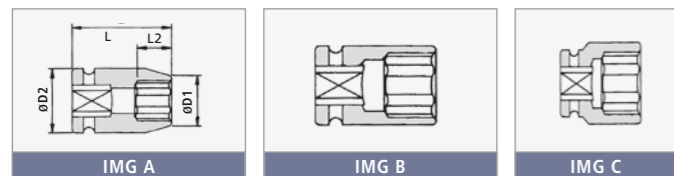

6-POINT UNIVERSAL JOINT NORMAL 3

6-Kant Kugelgelenkschlüssel normal
6-Pans Cardan normale

Type	IMG	D1 mm	D2 mm	L mm	L2 mm
Metrical · Metrisch · Metriques					
DO1038-2-009	9 E	15	24	53	9
DO1038-2-010	10 E	15	24	53	9
DO1038-2-011	11 E	17	24	53	9
DO1038-2-012	12 E	19	24	53	12
DO1038-2-013	13 E	19	24	53	13
DO1038-2-014	14 E	21	24	53	13
DO1038-2-015	15 E	22	24	53	13
DO1038-2-016	16 E	23	24	53	13
DO1038-2-017	17 E	25	24	53	13
DO1038-2-018	18 E	25	24	53	13
DO1038-2-019	19 E	27	24	53	13
DO1038-2-020	20 E	30	24	53	13
DO1038-2-021	21 E	30	24	53	13
DO1038-2-022	22 E	32	24	53	13

6-POINT UNIVERSAL JOINT DEEP 4

6-Kant Kugelgelenkschlüssel tief
6-Pans Cardan profonde

Type	IMG	D1 mm	D2 mm	L mm	L2 mm
Metrical · Metrisch · Metriques					
DO1038-4-009	9 E	15	24	78	20
DO1038-4-010	10 E	15	24	78	20
DO1038-4-011	11 E	17	24	80	20
DO1038-4-012	12 E	19	24	80	20
DO1038-4-013	13 E	19	24	80	20
DO1038-4-014	14 E	21	24	80	20
DO1038-4-015	15 E	22	24	80	20
DO1038-4-016	16 E	23	24	80	20
DO1038-4-017	17 E	25	24	80	20
DO1038-4-018	18 E	25	24	80	20
DO1038-4-019	19 E	27	24	80	25
DO1038-4-020	20 E	30	24	80	25
DO1038-4-021	21 E	30	24	80	25
DO1038-4-022	22 E	32	24	80	25

Universal joints are not covered by the Action warranty.

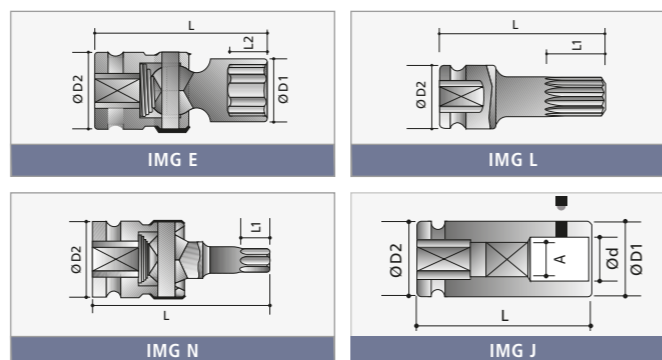

3/8" DRIVE | ANTRIEB | CARRÉ D'ENTRAÎNEMENT

TRIPLE SQUARE 1

Außen XZN
Carré triple

Type	IMG	D2 mm	L mm	L1 mm
Metrical · Metrisch · Metriques				
DO65216005	M5 L	19	50	7
DO65216006	M6 L	19	50	7
DO65216008	M8 L	19	50	9
DO65216010	M10 L	19	50	9
DO65216012	M12 L	19	50	11
DO65216014	M14 L	19	50	11
DO65216016	M16 L	19	50	13

TRIPLE SQUARE LONG 2

Außen XZN lang
Carré triple longue

Type	IMG	D2 mm	L mm	L1 mm
Metrical · Metrisch · Metriques				
DO65217005	M5 L	19	100	7
DO65217006	M6 L	19	100	7
DO65217008	M8 L	19	100	9
DO65217010	M10 L	19	100	9
DO65217012	M12 L	19	100	11
DO65217014	M14 L	19	100	11
DO65217016	M16 L	19	100	13
DO65218005	M5 L	19	120	7
DO65218006	M6 L	19	120	7
DO65218008	M8 L	19	120	9
DO65218010	M10 L	19	120	9
DO65218012	M12 L	19	120	11
DO65218014	M14 L	19	120	11
DO65218016	M14 L	19	120	13

TAP HOLDING SOCKETS 3

Gewindebohrhalter
Douille porte-taraud

Type	A mm	IMG	Ø D1 mm	Ø D2 mm	Ø d mm	L mm
Metrical · Metrisch · Metriques						
DO6321B001	3,4	J	19	19	4,5	38
DO6321B002	4,9	J	19	19	6,0	38
DO6321B003	5,5	J	19	19	7,0	40
DO6321B004	6,2	J	19	19	8,0	40
DO6321B005	7,0	J	19	19	9,0	43
DO6321B006	8,0	J	19	19	10,0	45
DO6321B007	9,0	J	19	19	11,0	45
DO6321B008	9,0	J	22	22	12,0	45
DO6321B009	11,0	J	22	22	14,0	45

UNIVERSAL JOINT HEX HEAD 6-POINT 4

Außen-6-Kant (Inbus)
Empreinte 6-pans (inbus)

Type	IMG	D2 mm	L mm	L2 mm
Metrical · Metrisch · Metriques				
DO65110005	5 N	24	60	11
DO65110006	6 N	24	60	11
DO65110007	7 N	24	60	15
DO65110008	8 N	24	60	15
DO65110009	9 N	24	60	15
DO65110010	10 N	24	60	15
DO65110011	11 N	24	60	15
DO65110012	12 N	24	60	15
DO65110013	13 N	24	60	15
DO65110014	14 N	24	60	15
DO65110015	15 N	24	60	15
DO65110016	16 N	24	60	15

Universal joints are not covered by the ACTION warranty.

UNIVERSAL JOINT FOR TORX® INTERNAL 5

Kugelgelenkschlüssel für intern Torx®
Cardan Torx® intérieure

Type	IMG	D2 mm	L mm
Metrical · Metrisch · Metriques			
DO64910020	T20 N	24	60
DO64910025	T25 N	24	60
DO64910027	T27 N	24	60
DO64910030	T30 N	24	60
DO64910040	T40 N	24	60
DO64910045	T45 N	24	60
DO64910047	T47 N	24	60
DO64910050	T50 N	24	60
DO64910055	T55 N	24	60

Universal joints are not covered by the ACTION warranty.

UNIVERSAL JOINT FOR TORX® EXTERNAL 6

Kugelgelenkschlüssel für extern Torx®
Cardan Torx® extérieure

Type	IMG	D2 mm	L mm	L2 mm
Metrical · Metrisch · Metriques				
DO68710005	E5 E	24	50	4,5
DO68710006	E6 E	24	50	5
DO68710007	E7 E	24	50	6
DO68710008	E8 E	24	50	6
DO68710010	E10 E	24	50	7,5
DO68710012	E12 E	24	50	8,5
DO68710014	E14 E	24	50	10
DO68710016	E16 E	24	50	11

Universal joints are not covered by the ACTION warranty.

PIN AND RING

Ring und Stift
Joint torique clavette





3/8" DRIVE | ANTRIEB | CARRÉ D'ENTRAÎNEMENT

HEX DRIVER 6-POINT (INBUS) 1

Außen-6-Kant (Inbus)
Empreinte 6-pans (inbus)

Type	IMG	D2 mm	L mm	L1 mm	-
------	-----	-------	------	-------	---

Metrical · Metrisch · Metriques

DO696203A	3	P	19	50	16	-
DO696204A	4	P	19	50	16	-
DO696205A	5	P	19	50	16	-
DO696206A	6	P	19	50	16	-
DO696207A	7	P	19	50	16	-
DO696208A	8	P	19	50	16	-
DO696209A	9	P	19	50	16	-
DO696210A	10	P	19	50	16	-
DO696211A	11	P	19	50	16	-
DO696212A	12	P	19	50	16	-
DO696213A	13	P	19	50	16	-
DO696214A	14	P	19	50	16	-
DO696215A	15	P	19	50	16	-
DO696216A	16	P	19	50	16	-

DO64819003	3	P	19	150	16	-
DO64819004	4	P	19	150	16	-
DO64819005	5	P	19	150	16	-
DO64819006	6	P	19	150	16	-
DO64819007	7	P	19	150	16	-
DO64819008	8	P	19	150	16	-
DO64819009	9	P	19	150	16	-
DO64819010	10	P	19	150	16	-
DO64819011	11	P	19	150	16	-
DO64819012	12	P	19	150	16	-
DO64819013	13	P	19	150	16	-
DO64819014	14	P	19	150	16	-
DO64819015	15	P	19	150	16	-
DO64819016	16	P	19	150	16	-

RIBE DRIVER 2

RIBE Profil
Profil Ribe

Type	IMG	D2 mm	L mm	L1 mm	-
------	-----	-------	------	-------	---

Metrical · Metrisch · Metriques

DO65315005	M5	H	19	50	4,5	-
DO65315006	M6	H	19	50	5	-
DO65315007	M7	H	19	50	6,5	-
DO65315008	M8	H	19	50	7,5	-
DO65315010	M10	H	19	50	9	-
DO65315012	M12	H	19	50	10	-
DO65315014	M14	H	19	50	12	-
DO65315016	M16	H	19	50	14	-

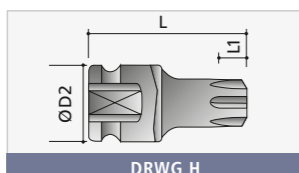
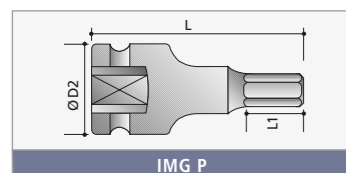

1/2" DRIVE | ANTRIEB | CARRÉ D'ENTRAÎNEMENT

4-POINT NORMAL 3

4-Kant normal
4-Pans normale

Type	IMG	D1 mm	D2 mm	L mm	L2 mm
------	-----	-------	-------	------	-------

Metrical · Metrisch · Metriques

DO63125008	8	A	19	25	40	9
DO63125010	10	A	21,5	25	40	10
DO63125011	11	A	23	25	40	11
DO63125012	12	A	24	25	40	12
DO63125013	13	A	26	30	40	12
DO63125014	14	A	27,5	30	40	20
DO63125016	16	B	30	30	40	20
DO63125017	17	C	32	30	40	20
DO63125019	19	C	36	30	45	20
DO63125021	21	C	40	30	45	20
DO63125022	22	C	42	30	45	20
DO63125024	24	C	44	30	50	22
DO63125030	30	C	53	30	50	22
DO63125032	32	C	56	30	50	22

DOUBLE SQUARE 4

Doppel-4-Kant
Douille octogonale

Type	IMG	D1 mm	D2 mm	L mm	L2 mm
------	-----	-------	-------	------	-------

Metrical · Metrisch · Metriques

DO2012-8-017	17	B	30	30	38	11
DO2012-8-019	19	B	34	34	40	13
DO2012-8-022	22	B	38	38	40	15
DO2012-8-024	24	B	42	38	45	18
DO2012-8-027	27	B	46,5	46,5	50	19
DO2012-8-028	28	B	49	49	50	19

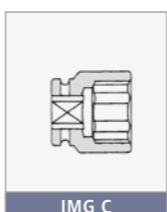
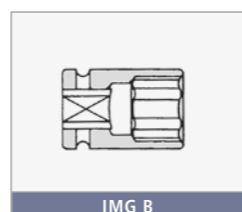
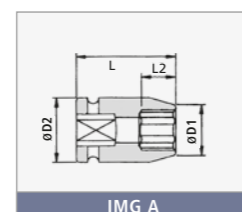

1/2" IMPACT SOCKETS | 1/2" KRAFTSTECKSCHLÜSSEL | 1/2" DOUILLES À CHOC





1/2" DRIVE | ANTRIEB | CARRÉ D'ENTRAÎNEMENT

6-POINT NORMAL 1

6-Kant normal
6-Pans normale

Type	IMG	D1 mm	D2 mm	L mm	L2 mm
Metrical · Metrisch · Metriques					
DO2012-0-008	8 A	14,5	25	38	9
DO2012-0-009	9 A	16	25	38	12
DO2012-0-010	10 A	17	25	38	12
DO2012-0-011	11 A	19	25	38	12
DO2012-0-012	12 A	20	24	38	12
DO2012-0-013	13 A	21	25	38	12
DO2012-0-014	14 A	22	25	38	12
DO2012-0-015	15 A	24	30	38	12
DO2012-0-016	16 A	25	30	38	12
DO2012-0-017	17 A	26	30	38	13
DO2012-0-018	18 A	27,5	30	38	13
DO2012-0-019	19 A	29	30	38	13
DO2012-0-020	20 B	30	30	38	13
DO2012-0-021	21 B	32	30	38	13
DO2012-0-022	22 C	32	30	38	13
DO2012-0-023	23 C	32,5	30	38	13
DO2012-0-024	24 C	35	30	45	20
DO2012-0-025	25 C	36	30	45	20
DO2012-0-026	26 C	37,5	30	45	22
DO2012-0-027	27 C	39	30	50	22
DO2012-0-028	28 C	40	30	50	22
DO2012-0-029	29 C	41	30	50	22
DO2012-0-030	30 C	42,5	30	50	22
DO2012-0-032	32 C	44	30	50	28
DO2012-0-034	34 C	45	30	50	28
DO2012-0-036	36 C	48	30	50	28
DO2012-0-038	38 C	53	38	50	24
DO2012-0-041	41 C	58	44	60	27
DO2012-0-046	46 C	65	44	70	30

6-POINT NORMAL 1

6-Kant normal
6-Pans normale

Type	IMG	D1 mm	D2 mm	L mm	L2 mm
SAE · Zoll · Pouce					
DO2012-0-3/8	3/8" A	16	22	38	12
DO2012-0-7/16	7/16" A	18	22	38	12
DO2012-0-1/2	1/2" A	20	22	38	12
DO2012-0-9/16	9/16" A	22	24	38	12
DO2012-0-5/8	5/8" B	25	25	38	12
DO2012-0-11/16	11/16" B	26	26	38	13
DO2012-0-3/4	3/4" B	28	28	38	13
DO2012-0-13/16	13/16" B	30	30	38	13
DO2012-0-7/8	7/8" B	32	32	38	13
DO2012-0-15/16	15/16" B	34	34	38	13
DO2012-0-1	1" B	36	36	38	14
DO2012-0-1 1/16	1 1/16" B	38	38	40	16
DO2012-0-1 1/8	1 1/8" C	40	38	40	16
DO2012-0-1 3/16	1 3/16" C	42	38	40	16
DO2012-0-1 1/4	1 1/4" C	44	38	40	18
DO2012-0-1 3/8	1 3/8" C	48,5	38	50	26
DO2012-0-1 7/16	1 7/16" C	50,5	38	50	26
DO2012-0-1 1/2	1 1/2" C	52,5	38	50	26

6-POINT NORMAL MAGNETIC 2

6-Kant normal magnetisch
6-Pans normale magnétique

Type	IMG	D1 mm	D2 mm	L mm	L2 mm
Metrical · Metrisch · Metriques					
DO6052P008	8 A	15	25	38	3
DO6052P009	9 A	16	25	38	4
DO6052P010	10 A	17,5	25	38	4
DO6052P011	11 A	18,5	25	38	5
DO6052P012	12 A	20	25	38	5
DO6052P013	13 A	21	25	38	5
DO6052P014	14 A	22,5	25	38	6
DO6052P015	15 A	23,7	30	38	6
DO6052P016	16 A	25	30	38	6
DO6052P017	17 A	26,5	30	38	6
DO6052P018	18 A	27,5	30	38	7
DO6052P019	19 A	29	30	38	7
DO6052P020	20 B	30	30	38	7
DO6052P021	21 C	31	30	38	8
DO6052P022	22 C	32,5	30	38	8
DO6052P024	24 C	35	30	45	10

6-POINT DEEP 3

6-Kant tief
6-Pans profonde

Type	IMG	D1 mm	D2 mm	L mm	L2 mm
Metrical · Metrisch · Metriques					
DO2012-1-008	8 A	14,5	25	78	13
DO2012-1-009	9 A	16	25	78	14
DO2012-1-010	10 A	17	25	78	14
DO2012-1-011	11 A	18	25	78	14
DO2012-1-012	12 A	19,5	25	78	14
DO2012-1-013	13 A	21	25	78	14
DO2012-1-014	14 A	22	25	78	17
DO2012-1-015	15 A	23,5	30	78	17
DO2012-1-016	16 A	23,5	30	78	17
DO2012-1-017	17 A	26	30	78	17
DO2012-1-018	18 A	26	30	78	17
DO2012-1-019	19 A	28	30	78	19
DO2012-1-020	20 B	30,5	30	78	19
DO2012-1-021	21 B	31	30	78	24
DO2012-1-022	22 C	32,5	30	78	24
DO2012-1-023	23 C	32,5	30	78	24
DO2012-1-024	24 C	35	30	78	24
DO2012-1-025	25 C	36	30	78	24
DO2012-1-026	26 C	37,5	30	78	24
DO2012-1-027	27 C	38	30	78	24
DO2012-1-028	28 C	40	30	78	24
DO2012-1-029	29 C	40	30	78	24
DO2012-1-030	30 C	42	30	78	24
DO2012-1-031	31 C	43	30	78	24
DO2012-1-032	32 C	45	30	78	24
DO2012-1-033	33 C	45	30	90	24
DO2012-1-034	34 C	45	30	90	24
DO2012-1-035	35 C	47	30	90	24
DO2012-1-036	36 C	49	30	90	24
DO2012-1-041	41 C	48	44	93	58
DO2012-1-046	46 C	65	44	93	58

1/2" DRIVE | ANTRIEB | CARRÉ D'ENTRAÎNEMENT

6-POINT DEEP 1

6-Kant tief
6-Pans profonde

Type	IMG	D1 mm	D2 mm	L mm	L2 mm
SAE · Zoll · Pouce					
DO2012-1-3/8	7/16" A	16	22	78	14
DO2012-1-7/16	7/16" A	18	22	78	14
DO2012-1-1/2	1/2" A	20	22	78	14
DO2012-1-9/16	9/16" A	22	24	78	17
DO2012-1-5/8	5/8" B	26	26	78	17
DO2012-1-11/16	11/16" B	26	26	78	17
DO2012-1-3/4	3/4" B	28	28	78	19
DO2012-1-13/16	13/16" B	30	30	78	24
DO2012-1-7/8	7/8" B	32	32	78	24
DO2012-1-15/16	15/16" B	28	28	78	54
DO2012-1-1	1" B	36	36	78	54
DO2012-1-1/16	1-1/16" B	38	38	78	54
DO2012-1-1/8	1-1/8" C	40	38	78	54
DO2012-1-3/16	1-3/16" C	42	38	78	54
DO2012-1-1/4	1-1/4" C	44	38	78	54
DO2012-1-5/16	1-5/16" C	45	38	78	54
DO2012-1-3/8	1-3/8" C	48,5	38	78	54
DO2012-1-7/16	1-7/16" C	50,5	38	78	54
DO2012-1-1/2	1-1/2" C	52,5	38	78	54

6-POINT DEEP MAGNETIC 2

6-Kant tief magnetisch
6-Pans profonde magnétique

Type	IMG	D1 mm	D2 mm	L mm	L2 mm
Metrical · Metrisch · Metriques					
DO6052R008	8 A	15	25	78	3
DO6052R009	9 A	16	25	78	4
DO6052R010	10 A	17,5	25	78	4
DO6052R011	11 A	18,5	25	78	5
DO6052R012	12 A	20	25	78	5
DO6052R013	13 A	21	25	78	5
DO6052R014	14 A	22,5	25	78	6
DO6052R015	15 A	23,7	30	78	6
DO6052R016	16 A	25	30	78	6
DO6052R017	17 A	26,5	30	78	6
DO6052R018	18 A	27,5	30	78	7
DO6052R019	19 A	29	30	78	7
DO6052R020	20 B	30	30	78	7
DO6052R021	21 C	31	30	78	8
DO6052R022	22 C	32,5	30	78	8
DO6052R024	24 C	35	30	78	10

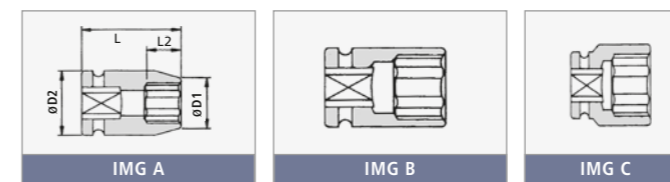

6-POINT THIN WALL NORMAL 3

6-Kant dünnwandig normal
6-Pans paroi mince normales

Type	IMG	D1 mm	D2 mm	L mm	L2 mm
Metrical · Metrisch · Metriques					
DO61120008	8 A	13	25	38	6
DO61120009	9 A	14,5	25	38	6
DO61120010	10 A	15,5	25	38	7
DO61120011	11 A	16,7	25	38	8
DO61120012	12 A	18	25	38	9
DO61120013	13 A	19,2	25	38	9
DO61120014	14 A	21	25	38	11
DO61120015	15 A	21,7	30	38	11
DO61120016	16 A	23	30	38	11
DO61120017	17 B	24	30	38	11
DO61120018	18 B	25	30	38	13
DO61120019	19 B	26	30	38	13
DO61120020	20 B	27,5	30	38	13
DO61120021	21 B	28	30	38	15
DO61120022	22 B	29,5	30	38	15
DO61120023	23 C	30,5	30	38	15
DO61120024	24 C	32	30	45	18

Thin wall sockets are not covered by the ACTION warranty.

6-POINT THIN WALL DEEP 4

6-Kant dünnwandig tief
6-Pans paroi mince profonde

Type	IMG	D1 mm	D2 mm	L mm	L2 mm
Metrical · Metrisch · Metriques					
DO61122008	8 A	14	22	78	13
DO61122009	9 A	14,5	22	78	14
DO61122010	10 A	15,5	22	78	14
DO61122011	11 A	16,7	22	78	14
DO61122012	12 A	18	22	78	14
DO61122013	13 A	19,2	24	78	14
DO61122014	14 A	21	24	78	17
DO61122015	15 A	21,7	24	78	17
DO61122016	16 A	23	24	78	17
DO61122017	17 B	24	24	78	17
DO61122018	18 B	25	25	78	17
DO61122019	19 B	26	26	78	19
DO61122020	20 B	27,5	27,5	78	19
DO61122021	21 B	28	28	78	24
DO61122022	22 B	29,5	29,5	78	24
DO61122023	23 B	30,5	30,5	78	24
DO61122024	24 B	32	32	78	24
DO61122025	25 B	33	33	78	24
DO61122026	26 B	35	35	78	24
DO61122027	27 B	36	36	78	24
DO61122028	28 B	37,5	37,5	78	24
DO61122029	29 C	38,5	38	78	24
DO61122030	30 C	40	38	78	24
DO61122031	31 C	41	38	78	24
DO61122032	32 C	42	38	78	24



1/2" DRIVE | ANTRIEB | CARRÉ D'ENTRAÎNEMENT

6-POINT L=150 1

Type	IMG	D1 mm	D2 mm	L mm	L2 mm
Metrical · Metrisch · Métriques					
DO60725008	8 G	15	25	150	10
DO60725010	10 G	17,5	25	150	12
DO60725012	12 G	19,5	25	150	12
DO60725013	13 G	21	25	150	12
DO60725014	14 G	22,5	25	150	12
DO60725015	15 G	23,5	30	150	12
DO60725017	17 G	26	30	150	13
DO60725019	19 G	28,5	30	150	13
DO60725020	20 G	30	30	150	13
DO60725021	21 G	31	30	150	13
DO60725025	25 G	36	30	150	15

6-POINT L=200 2

Type	IMG	D1 mm	D2 mm	L mm	L2 mm
Metrical · Metrisch · Métriques					
DO60726008	8 G	15	25	200	10
DO60726010	10 G	17,5	25	200	12
DO60726012	12 G	20	25	200	12
DO60726013	13 G	20	25	200	12
DO60726014	14 G	21	25	200	12
DO60726015	15 G	23,5	30	200	12
DO60726017	17 G	26	30	200	13
DO60726019	19 G	28,5	30	200	13
DO60726020	20 G	30	30	200	13
DO60726021	21 G	31	30	200	13

6-POINT L=250 3

Type	IMG	D1 mm	D2 mm	L mm	L2 mm
Metrical · Metrisch · Métriques					
DO60727008	8 G	15	25	250	10
DO60727010	10 G	17,5	25	250	12
DO60727012	12 G	20	25	250	12
DO60727013	13 G	20,5	25	250	12
DO60727014	14 G	22,5	25	250	12
DO60727015	15 G	23,5	30	250	12
DO60727017	17 G	26	30	250	13
DO60727019	19 G	28,5	30	250	13
DO60727020	20 G	30	30	250	13
DO60727021	21 G	31	30	250	13
DO60727022	22 G	32	30	250	14

6-POINT THIN WALL DEEP WITH PLASTIC STOP AND SLEEVE 4

Type	IMG	D1 mm	D2 mm	L mm	L2 mm
Metrical · Metrisch · Métriques					
DO61126015 (white)	15 H	22	30	85	13
DO61126017 (blue)	17 H	27	30	85	14
DO61126019 (yellow)	19 H	29	30	85	15
DO61126021 (red)	21 H	31	30	85	17
DO61126022 (green)	22 H	32,5	30	85	18
DO6112J017 (blue)	17 H	27	25	130	24
DO6112J019 (yellow)	19 H	29	30	130	24
DO6112J021 (red)	21 H	31	30	130	24
DO6112J022 (green)	22 H	32,5	30	130	24

Thin wall sockets are not covered by the Action warranty.

6-POINT L=250 FOR WHEEL NUTS 5

Type	IMG	D1 mm	D2 mm	L mm	L2 mm
Metrical · Metrisch · Métriques					
DO60529019	19 G	28	28	250	13
DO60529021	21 G	31	28	250	13
DO60529024	24 G	35	28	250	15
DO60529027	27 G	38,5	32	250	17

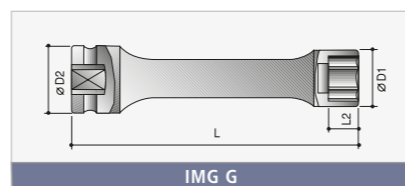
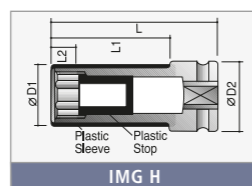

1/2" DRIVE | ANTRIEB | CARRÉ D'ENTRAÎNEMENT

12-POINT NORMAL 1

Type	IMG	D1 mm	D2 mm	L mm	L2 mm
Metrical · Metrisch · Métriques					
DO63825006	6 A	13	25	38	5
DO63825008	8 A	15	25	38	6
DO63825009	9 A	16	25	38	6
DO63825010	10 A	17,5	25	38	7
DO63825011	11 A	19	25	38	8
DO63825012	12 A	20	25	38	9
DO63825013	13 A	21	25	38	9
DO63825014	14 A	22,5	25	38	11
DO63825015	15 A	23,5	30	38	11
DO63825016	16 A	25	30	38	11
DO63825017	17 A	26,5	30	38	11
DO63825018	18 A	27,5	30	40	13
DO63825019	19 A	29	30	40	13
DO63825020	20 B	30	30	40	13
DO63825021	21 C	31	30	40	15
DO63825022	22 C	32,5	30	40	15
DO63825023	23 C	34	30	40	15
DO63825024	24 C	35	30	45	18
DO63825025	25 C	36	30	45	18
DO63825026	26 C	38	30	50	18
DO63825027	27 C	39	30	50	19
DO63825028	28 C	40	30	50	19
DO63825029	29 C	41	30	50	19
DO63825030	30 C	42,5	30	50	21
DO63825032	32 C	45	30	50	22
DO63825033	33 C	46,5	30	50	22
DO63825036	36 C	50,5	30	50	24
DO63825041	41 C	58,5	44	60	27
DO63825046	46 C	65	44	70	30

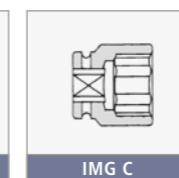
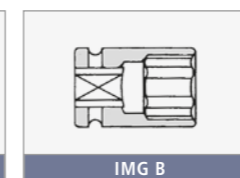
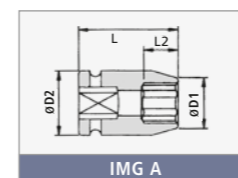

12-POINT DEEP 2

Type	IMG	D1 mm	D2 mm	L mm	L2 mm
Metrical · Metrisch · Métriques					
DO65827006	6 A	13	25	83	5
DO65827007	7 A	14	25	83	5
DO65827008	8 A	15	25	83	6
DO65827009	9 A	16	25	83	6
DO65827010	10 A	17,5	25	83	7
DO65827011	11 A	19	25	83	8
DO65827012	12 A	20	25	83	9
DO65827013	13 A	21	25	83	9
DO65827014	14 A	22,5	25	83	11
DO65827015	15 A	23,5	30	83	11
DO65827016	16 A	25	30	83	11
DO65827017	17 A	26,5	30	83	11
DO65827018	18 A	27,5	30	83	13
DO65827019	19 A	29	30	83	13
DO65827020	20 B	30	30	83	13
DO65827021	21 C	31	30	83	15
DO65827022	22 C	32,5	30	90	15
DO65827023	23 C	34	30	90	15
DO65827024	24 C	35	30	90	18
DO65827025	25 C	36	30	90	18
DO65827026	26 C	38	30	90	18
DO65827027	27 C	39	30	90	19
DO65827028	28 C	40	30	90	19
DO65827029	29 C	41	30	90	19
DO65827030	30 C	42,5	30	90	21
DO65827031	31 C	44	30	90	21
DO65827032	32 C	45	30	90	22
DO65827033	33 C	46,5	30	90	22
DO65827034	34 C	48	30	90	22
DO65827035	35 C	49,5	30	90	22
DO65827036	36 C	50,5	30	90	24
DO65827038	38 C	53	38	90	24
DO65827039	39 C	54,5	44	93	24
DO65827040	40 C	56	44	93	58
DO65827041	41 C	58,5	44	93	58
DO65827042	42 C	60	44	93	58
DO65827043	43 C	61	44	93	58
DO65827044	44 C	63	44	93	58
DO65827045	45 C	64	44	93	58
DO65827046	46 C	65	44	93	58
DO65827047	47 C	66,5	44	93	58
DO65827048	48 C	68	44	93	58
DO65827049	49 C	69	44	93	58
DO65827050	50 C	70	52	93	58
DO65827051	51 C	71	52	93	58
DO65827052	52 C	72,5	52	93	58
DO65827054	54 C	75	52	93	58
DO65827056	56 C	77	52	93	58
DO65827057	57 C	78	52	93	58
DO65827058	58 C	79	52	93	58



1/2" DRIVE | ANTRIEB | CARRÉ D'ENTRAÎNEMENT

SURFACE DRIVE NORMAL 1

Surface Drive normal
Surface Drive normale

Type	IMG	D1 mm	D2 mm	L mm	L2 mm
Metrical · Metrisch · Métriques					
DO63425010	10	A	17,5	25	38
DO63425011	11	A	18,7	25	38
DO63425012	12	A	20	25	38
DO63425013	13	A	21	25	38
DO63425014	14	A	22,5	25	38
DO63425015	15	A	23,7	30	38
DO63425016	16	A	25	30	38
DO63425017	17	A	26	30	38
DO63425018	18	A	27,5	30	38
DO63425019	19	A	28,7	30	38
DO63425020	20	B	30	30	38
DO63425021	21	B	30	30	38
DO63425022	22	C	32	30	38
DO63425023	23	C	32	30	38
DO63425024	24	C	35	30	45
DO63425026	26	C	38	30	50
DO63425027	27	C	38,7	30	50
DO63425029	29	C	40	30	50
DO63425030	30	C	42	30	50
DO63425032	32	C	44	30	50

SURFACE DRIVE DEEP 2

Surface Drive tief
Surface Drive profonde

Type	IMG	D1 mm	D2 mm	L mm	L2 mm
Metrical · Metrisch · Métriques					
DO63427010	10	A	17,5	25	83
DO63427011	11	A	18,7	25	83
DO63427012	12	A	20	25	83
DO63427013	13	A	21	25	83
DO63427014	14	A	22,5	25	83
DO63427015	15	A	23,7	30	83
DO63427016	16	A	25	30	83
DO63427017	17	A	26	30	83
DO63427018	18	A	27,5	30	83
DO63427019	19	A	28,7	30	83
DO63427020	20	B	30	30	83
DO63427021	21	B	30	30	83
DO63427022	22	C	32	30	90
DO63427023	23	C	32	30	90
DO63427024	24	C	35	30	90
DO63427026	26	C	38	30	90
DO63427027	27	C	38,7	30	90
DO63427029	29	C	40	30	90
DO63427030	30	C	42	30	90
DO63427032	32	C	44	30	90

TORX® INTERNAL 3

Torx® intern
Torx® intérieure

Type	IMG	D2 mm	L1 mm	L mm
DO64721020	T20	F	25	2,8
DO64721025	T25	F	25	3,0
DO64721027	T27	F	25	3,0
DO64721030	T30	F	25	3,8
DO64721040	T40	F	25	3,8
DO64721045	T45	F	25	4,3
DO64721047	T47	F	25	5,0
DO64721050	T50	F	25	5,0
DO64721055	T55	F	25	5,5
DO64721060	T60	F	25	8,0
DO64721070	T70	F	25	9,4

TORX® INTERNAL LONG 4

Torx® intern Lang
Torx® intérieure longue

Type	IMG	D2 mm	L1 mm	L mm
DO64722020	T20	F	25	2,8
DO64722025	T25	F	25	3,0
DO64722027	T27	F	25	3,0
DO64722030	T30	F	25	3,8
DO64722040	T40	F	25	3,8
DO64722045	T45	F	25	4,3
DO64722047	T47	F	25	5,0
DO64722050	T50	F	25	5,0
DO64722055	T55	F	25	5,5
DO64722060	T60	F	25	8,0
DO64722070	T70	F	25	9,4
DO64725025	T25	F	25	3,0
DO64725027	T27	F	25	3,0
DO64725030	T30	F	25	3,8
DO64725040	T40	F	25	3,8
DO64725045	T45	F	25	4,3

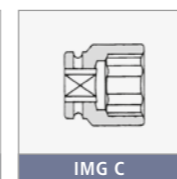
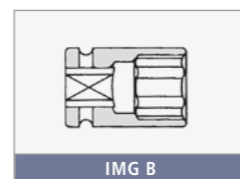
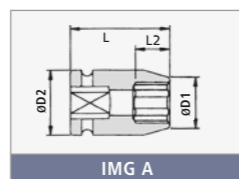
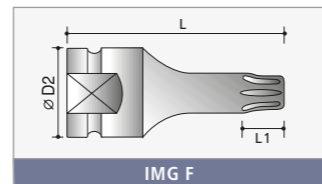

1/2" DRIVE | ANTRIEB | CARRÉ D'ENTRAÎNEMENT

TORX® TAMPER RESISTANT INTERNAL 1

Torx® Tamper Resistant intern
Torx® Tamper Resistant intérieure

Type	IMG	D2 mm	L1 mm	L mm
DO64726020	T20	F	25	2,8
DO64726025	T25	F	25	3,0
DO64726027	T27	F	25	3,0
DO64726030	T30	F	25	3,8
DO64726040	T40	F	25	3,8
DO64726045	T45	F	25	4,3
DO64726047	T47	F	25	5,0
DO64726050	T50	F	25	5,0
DO64726055	T55	F	25	5,5
DO64726060	T60	F	25	8,0
DO64726070	T70	F	25	9,4

TORX® TAMPER RESISTANT INTERNAL LONG 2

Torx® Tamper Resistant intern lang
Torx® Tamper Resistant longue

Type	IMG	D2 mm	L1 mm	L mm
DO64727020	T20	F	25	2,8
DO64727025	T25	F	25	3,0
DO64727027	T27	F	25	3,0
DO64727030	T30	F	25	3,8
DO64727040	T40	F	25	3,8
DO64727045	T45	F	25	4,3
DO64727047	T47	F	25	5,0
DO64727050	T50	F	25	5,0
DO64727055	T55	F	25	5,5
DO64727060	T60	F	25	8,0
DO64727070	T70	F	25	9,4

TORX® EXTERNAL 3

Torx® extern
Torx® extérieure

Type	IMG	D1 mm	D2 mm	L mm	L2 mm
DO63320010	E10	A	15	25	38
DO63320011	E11	A	15,5	25	38
DO63320012	E12	A	16	25	38
DO63320014	E14	A	18,5	25	38
DO63320016	E16	A	20	25	38
DO63320018	E18	A	22	25	38
DO63320020	E20	A	25	30	38
DO63320022	E22	A	26,5	30	45
DO63320024	E24	A	28,5	30	45

TORX® THIN WALL EXTERNAL 4

Torx® dünnwandig extern
Torx® à paroi mince extérieure

Type	IMG	D1 mm	D2 mm	L mm	L2 mm
DO63325010	E10	A	13	25	38
DO63325011	E11	A	14	25	38
DO63325012	E12	A	15	25	38
DO63325014	E14	A	17	25	38
DO63325016	E16	A	18,5	25	38
DO63325018	E18	A	20,5	25	38
DO63325020	E20	A	22,5	30	38
DO63325022	E22	A	24,5	30	45
DO63325024	E24	A	26,5	30	45

Thin wall sockets are not covered by the Action warranty.

TORX® EXTERNAL MAGNETIC 5

Torx® extern magnetisch
Torx® extérieure magnétique

Type	IMG	D1 mm	D2 mm	L mm	L2 mm
Metrical · Metrisch · Métriques					
DO6332N010	E10	A	14,5	25	38
DO6332N011	E11	A	15	25	38
DO6332N012	E12	A	16	25	38
DO6332N014	E14	A	18	25	38
DO6332N016	E16	A	20	25	38
DO6332N018	E18	A	22	25	38
DO6332N020	E20	A	25	30	38
DO6332N022	E22	A	27	30	45
DO6332N024	E24	A	29	30	45

Torx® is a trademark of Textron.





1/2" DRIVE | ANTRIEB | CARRÉ D'ENTRAÎNEMENT

6-POINT UNIVERSAL JOINT NORMAL 1

6-Kant Kugelgelenkschlüssel normal
6-Pans Cardan normales

Type	IMG	D1 mm	D2 mm	L mm	L2 mm	
Metrical · Metrisch · Metriques						
DO2012-2-010	10	E	15	28	65	14
DO2012-2-011	11	E	17	28	65	14
DO2012-2-012	12	E	19	28	65	14
DO2012-2-013	13	E	20	28	65	14
DO2012-2-014	14	E	22	28	65	14
DO2012-2-015	15	E	23	28	65	14
DO2012-2-016	16	E	23	28	65	14
DO2012-2-017	17	E	26	32	65	14
DO2012-2-018	18	E	26	32	65	14
DO2012-2-019	19	E	28	32	65	14
DO2012-2-020	20	E	30	32	65	14
DO2012-2-021	21	E	30	32	65	14
DO2012-2-022	22	E	32	32	65	14
DO2012-2-023	23	E	32	32	65	14
DO2012-2-024	24	E	34	32	65	14

Universal joints are not covered by the Action warranty.

6-POINT UNIVERSAL JOINT DEEP 2

6-Kant Kugelgelenkschlüssel tief
6-Pans Cardan profonde

Type	IMG	D1 mm	D2 mm	L mm	L2 mm	
Metrical · Metrisch · Metriques						
DO2012-4-010	10	E	15	28	90	14
DO2012-4-011	11	E	17	28	90	20
DO2012-4-012	12	E	19	28	90	20
DO2012-4-013	13	E	20	28	90	20
DO2012-4-014	14	E	22	28	90	20
DO2012-4-015	15	E	23	28	90	20
DO2012-4-016	16	E	23	28	90	20
DO2012-4-017	17	E	26	32	90	20
DO2012-4-018	18	E	26	32	90	20
DO2012-4-019	19	E	28	32	90	25
DO2012-4-020	20	E	30	32	90	25
DO2012-4-021	21	E	30	32	90	25
DO2012-4-022	22	E	32	32	90	25
DO2012-4-023	23	E	32	32	90	25
DO2012-4-024	24	E	34	32	90	25

Universal joints are not covered by the Action warranty.

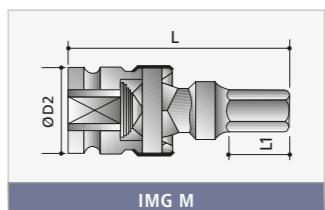
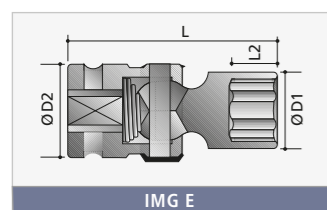

UNIVERSAL JOINT FOR TORX® INTERNAL 3

Kugelgelenkschlüssel für intern Torx®
Cardan Torx® intérieure

Type	IMG	D2 mm	L mm	L1 mm		
DO64921025	T25	M	28	70	3	-
DO64921027	T27	M	28	70	3	-
DO64921030	T30	M	28	70	3,8	-
DO64921040	T40	M	28	70	3,8	-
DO64921045	T45	M	28	70	4,3	-
DO64921047	T47	M	28	70	5	-
DO64921050	T50	M	28	70	5	-
DO64921055	T55	M	28	70	5,5	-
DO64921060	T60	M	28	70	8	-

Universal joints are not covered by the Action warranty.

UNIVERSAL JOINT FOR TORX® EXTERNAL 4

Kugelgelenkschlüssel für Torx® extern
Cardan Torx® extérieure

Type	IMG	D1 mm	D2 mm	L mm	L2 mm	
DO68720010	E10	E	13	28	65	7,5
DO68720011	E11	E	14	28	65	8,0
DO68720012	E12	E	15	28	65	8,5
DO68720014	E14	E	17	28	65	10
DO68720016	E16	E	18,5	28	65	11
DO68720018	E18	E	20,5	28	65	12
DO68720020	E20	E	22,5	32	70	13,5
DO68720022	E22	E	24,5	32	70	15
DO68720024	E24	E	26,5	32	70	17

Universal joints are not covered by the Action warranty.

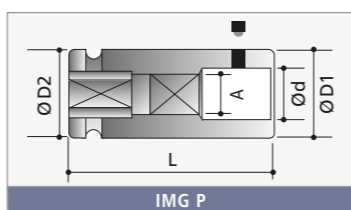
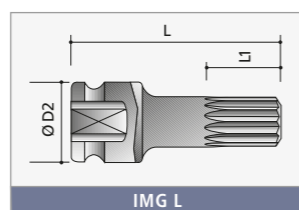

1/2" DRIVE | ANTRIEB | CARRÉ D'ENTRAÎNEMENT

HEX DRIVER (INBUS) 1

Außen-6-Kant (Inbus)
Empreinte 6-pans (inbus)

Type	IMG	D2 mm	L mm	L1 mm		
Metrical · Metrisch · Metriques						
DO696304A	4	K	25	75	11	-
DO696305A	5	K	25	75	15	-
DO696306A	6	K	25	75	15	-
DO696307A	7	K	25	75	15	-
DO696308A	8	K	25	75	16	-
DO696309A	9	K	25	75	16	-
DO696310A	10	K	25	75	16	-
DO696311A	11	K	25	75	16	-
DO696312A	12	K	25	75	16	-
DO696313A	13	K	25	75	16	-
DO696314A	14	K	25	75	16	-
DO696315A	15	K	25	75	16	-
DO696316A	16	K	25	75	16	-
DO696317A	17	K	25	75	16	-
DO696319A	19	K	25	75	16	-
DO696321A	21	K	30	75	16	-
DO696322A	22	K	30	75	16	-
DO64827006	6	K	25	100	15	-
DO64828006	6	K	25	125	15	-
DO64827008	8	K	25	100	16	-
DO64828008	8	K	25	125	16	-
DO64827010	10	K	25	100	16	-
DO64828010	10	K	25	125	16	-
DO64827012	12	K	25	100	16	-
DO64827014	14	K	25	100	16	-

TAP HOLDING SOCKETS 2

Gewindebohrerhalter
Douille port-taraud

Type	A mm	IMG	Ø D1 mm	Ø D2 mm	Ø d mm	L mm
Metrical · Metrisch · Metriques						
DO6322B001	3,4	P	22	22	4,5	40
DO6322B002	4,9	P	22	22	6,0	45
DO6322B003	5,5	P	22	22	7,0	45
DO6322B004	6,2	P	22	22	8,0	45
DO6322B005	7,0	P	22	22	9,0	45
DO6322B006	8,0	P	22	22	10,0	45
DO6322B007	9,0	P	22	22	11,0	45
DO6322B008	9,0	P	22	22	12,0	50
DO6322B009	11,0	P	22	22	14,0	52

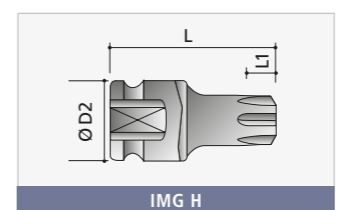
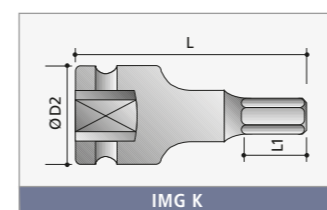

TRIPLE SQUARE BIT 3

Außen-XZN
Carré triple

Type	IMG	D2 mm	L mm	L1 mm		
Metrical · Metrisch · Metriques						
DO65226005	M5	L	25	55	7	-
DO65226006	M6	L	25	55	7	-
DO65226008	M8	L	25	55	9	-
DO65226010	M10	L	25	55	9	-
DO65226012	M12	L	25	55	11	-
DO65226014	M14	L	25	55	11	-
DO65226016	M16	L	25	55	13	-

TRIPLE SQUARE BIT LONG 4

Außen-XZN lang
Carré triple longue

Type	IMG	D2 mm	L mm	L1 mm		
Metrical · Metrisch · Metriques						
DO65227005	M5	L	25	100	7	-
DO65227006	M6	L	25	100	7	-
DO65227008	M8	L	25	100	9	-
DO65227010	M10	L	25	100	9	-
DO65227012	M12	L	25	100	11	-
DO65227014	M14	L	25	100	11	-
DO65227016	M16	L	25	100	13	-

TRIPLE SQUARE BIT EXTRA LONG 4

Außen-XZN extra lang
Carré triple extra longue

Type	IMG	D2 mm	L mm	L1 mm		
Metrical · Metrisch · Metriques						
DO65228008	M8	L	25	140	9	-
DO65228010	M10	L	25	140	9	-
DO65228012	M12	L	25	140	11	-
DO65228018	M18	L	25	140	14	-

RIBE DRIVER 5

RIBE Profile
Profile RIBE

Type	IMG	D2 mm	L mm	L1 mm		
Metrical · Metrisch · Metriques						
DO65326006	M6	H	25	55	5	-
DO65326007	M7	H	25	55	6,5	-
DO65326008	M8	H	25	55	7,5	-
DO65326010	M10	H	25	55	9	-
DO65326012	M12	H	25	55	10	-
DO65326014	M14	H	25	55	12	-
DO65326016	M16	H	25	55	14	-
DO65326018	M18	H	25	55	16	-

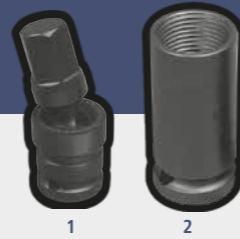

1/2" DRIVE | ANTRIEB | CARRÉ D'ENTRAÎNEMENT

HEX DRIVER WITH UNIVERSAL JOINT 1

Außen-6-Kant Kugelgelenkschlüssel
Cardan, empreinte 6-pans

Type	IMG	D2 mm	L mm	L1 mm	-
Metrical · Metrisch · Métriques					
DO65121006	6	M	28	75	13
DO65121007	7	M	28	75	13
DO65121008	8	M	28	75	20
DO65121009	9	M	28	75	20
DO65121010	10	M	28	75	20
DO65121011	11	M	28	75	20
DO65121012	12	M	28	75	20
DO65121013	13	M	28	75	20
DO65121014	14	M	28	75	20
DO65121015	15	M	28	75	20
DO65121016	16	M	28	75	20
DO65121017	17	M	28	75	20
DO65121018	18	M	28	75	20
DO65121019	19	M	28	75	20

STUD BOLT SETTERS

Stehbolzensetzer
Prise Goujon

Type	Size Gewinde Taille	D1 mm	D2 mm	L mm
DO69782010	M6 x 1,0	13	25	55
DO69782017	M8 x 1,0	15	25	55
DO69782018	M8 x 1,25	15	25	55
DO69782020	M10 x 1,0	18	25	55
DO69782021	M10 x 1,25	18	25	55
DO69782022	M10 x 1,5	17	25	55
DO69782025	M12 x 1,25	19	25	55
DO69782026	M12 x 1,5	19	25	55
DO69782027	M12 x 1,75	19	25	55
DO69782030	M14 x 1,5	23	25	55
DO69782031	M14 x 2,0	22	25	55
DO69782034	M16 x 1,5	28	30	75
DO69782035	M16 x 2,0	27	30	75
DO69782038	M18 x 2,5	29	30	75
DO69782040	M20 x 1,5	30	30	75
DO69782041	M20 x 2,5	30	30	75



WHEEL LUG NUT REMOVER SOCKETS 2

Radmutterkraftsteckschlüssel
Douilles pour depose de boulon de roue

Type	IMG	D1 mm	D2 mm	L mm	L1 mm
DO69782090	17	R	24	24	38
DO69782091	18,5	R	25	25	38
DO69782092	20	R	26	26	38
DO69782093	21,5	R	28,5	28,5	38
DO69782094	23	R	30	30	38
DO69782095	24,5	R	31	31	38
DO69782096	26	R	32	32	38

APPLICATION WHEEL LUG NUT REMOVERS SOCKETS

Anwendung der Radmutterkraftsteckschlüssel
Application douilles pour depose de boulons de roues

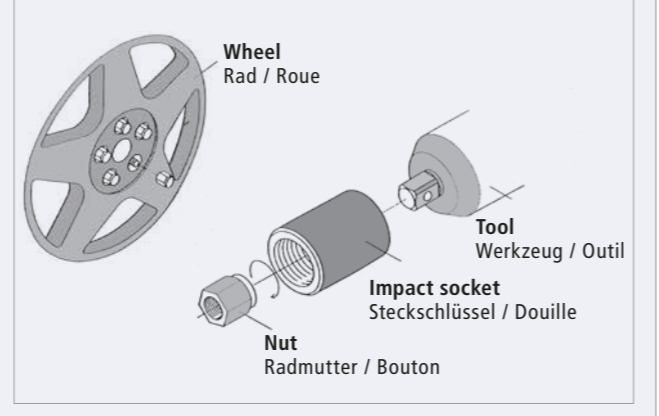

PIN AND RING

Ring und Stift
Joint torique clavette

DO1012-0-000

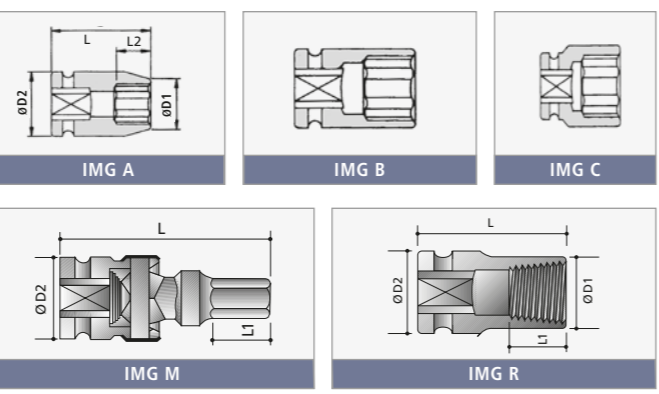

3/4" DRIVE | ANTRIEB | CARRÉ D'ENTRAÎNEMENT

4-POINT NORMAL 1

4-Kant normal
4-Pans normale

Type	IMG	D1 mm	D2 mm	L mm	L2 mm
Metrical · Metrisch · Métriques					
DO63045016	16	B	40	40	52
DO63045017	17	B	40	40	52
DO63045019	19	B	40	40	52
DO63045020	20	B	42	42	52
DO63045021	21	B	42	42	52
DO63045024	24	C	47	44	52

6-POINT NORMAL 2

6-Kant normal
6-Pans normale

Type	IMG	D1 mm	D2 mm	L mm	L2 mm
Metrical · Metrisch · Métriques					
DO3034-0-013	13	A	25	44	50
DO3034-0-014	14	A	25	44	50
DO3034-0-015	15	A	26	44	50
DO3034-0-016	16	A	27	44	50
DO3034-0-017	17	A	31	44	50
DO3034-0-018	18	A	32	44	50
DO3034-0-019	19	A	33	44	50
DO3034-0-020	20	A	34	44	50
DO3034-0-021	21	A	35	44	50
DO3034-0-022	22	A	37	44	50
DO3034-0-023	23	A	38	44	50
DO3034-0-024	24	A	40	44	50
DO3034-0-025	25	A	40	44	50
DO3034-0-026	26	A	41	44	50
DO3034-0-027	27	A	43	44	54
DO3034-0-028	28	B	44	44	54
DO3034-0-029	29	C	45	44	54
DO3034-0-030	30	C	47	44	54
DO3034-0-031	31	C	48	44	56
DO3034-0-032	32	C	49	44	56
DO3034-0-033	33	C	51	44	56
DO3034-0-034	34	C	52	44	56
DO3034-0-035	35	C	53	44	56
DO3034-0-036	36	C	54	44	56
DO3034-0-037	37	C	56	44	58
DO3034-0-038	38	C	57	44	58
DO3034-0-039	39	C	58	44	58
DO3034-0-040	40	C	58	44	58
DO3034-0-041	41	C	60	44	58
DO3034-0-042	42	C	62	44	58
DO3034-0-043	43	C	63	44	63
DO3034-0-044	44	C	65	44	63
DO3034-0-045	45	C	66	44	63
DO3034-0-046	46	C	67	44	63
DO3034-0-047	47	C	68	44	68
DO3034-0-048	48	C	69	44	68
DO3034-0-049	49	C	70	44	70

6-POINT NORMAL (CONTINUED) 2

6-Kant normal
6-Pans normale

Type	IMG	D1 mm	D2 mm	L mm	L2 mm
Metrical · Metrisch · Métriques					
DO3034-0-050	50	C	71	54	72
DO3034-0-055	55	C	77	54	74
DO3034-0-060	60	C	84	54	75
DO3034-0-063	63	C	86	54	75
DO3034-0-065	65	C	88	54	78
DO3034-0-067	67	C	90	54	80
DO3034-0-070	70	C	96	54	80
DO3034-0-075	75	C	102	64	83

6-POINT NORMAL 3

6-Kant normale
6-Pans normales

Type	IMG	D1 mm	D2 mm	L mm	L2 mm
SAE · Zoll · Pouce					
DO3034-0-11/16	11/16"	A	29	38	50
DO3034-0-3/4	3/4"	A	30	38	50
DO3034-0-13/16	13/16"	A	32	38	52
DO3034-0-7/8	7/8"	A	34	38	52
DO3034-0-15/16	15/16"	A	36	38	52
DO3034-0-1 1/8	1 1/8"	B	42	42	52
DO3034-0-1 3/16	1 3/16"	B	44	44	52
DO3034-0-1 1/4	1 1/4"	B	44	44	52
DO3034-0-1	1"	C	40	38	52
DO3034-0-1 1/16	1 1/16"	C	40	38	52
DO3034-0-1 5/16	1 5/16"	C	47	44	56
DO3034-0-1 3/8	1 3/8"	C	50	44	56
DO3034-0-1 7/16	1 7/16"	C	51	44	56
DO3034-0-1 1/2	1 1/2"	C	53	44	56
DO3034-0-1 3/4	1 3/4"	C	65	44	62
DO3034-0-1 13/16	1 13/16"	C	67	44	56

STUD BOLT SETTERS

Stehbolzensetzer
Prise Goujon

Type	Size Gewinde Taille	D1 mm	D2 mm	L mm
DO69784162	M16 x 2	29	44	100
DO69784203	M20 x 2,5	35	44	100
DO69784241	M24 x 1,5	37	44	100
DO69784244	M24 x 3	37	44	100
DO69784285	M28 x 3,5	42	44	100
DO69784305	M30 x 3,5	43	44	100

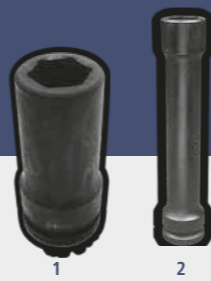

3/4" DRIVE | ANTRIEB | CARRÉ D'ENTRAÎNEMENT

6-POINT DEEP 1

6-Kant tief
6-Pans profonde

Type	IMG	D1 mm	D2 mm	L mm	L2 mm
Metrical · Metrisch · Metriques					
DO3034-1-013	13 A	25	44	95	13
DO3034-1-014	14 A	25	44	95	14
DO3034-1-015	15 A	26	44	95	15
DO3034-1-017	17 A	31	44	95	17
DO3034-1-018	18 A	32	44	95	18
DO3034-1-019	19 A	33	44	95	19
DO3034-1-020	20 A	34	44	95	20
DO3034-1-021	21 A	35	44	95	21
DO3034-1-022	22 A	37	44	95	22
DO3034-1-023	23 A	38	44	95	23
DO3034-1-024	24 A	39,5	44	95	24
DO3034-1-025	25 A	40	44	95	25
DO3034-1-026	26 A	41	44	95	26
DO3034-1-027	27 A	43	44	95	27
DO3034-1-028	28 B	44	44	95	28
DO3034-1-029	29 C	45	44	95	29
DO3034-1-030	30 C	47	44	95	30
DO3034-1-031	31 C	48	44	95	31
DO3034-1-032	32 C	49	44	95	32
DO3034-1-033	33 C	51	44	95	33
DO3034-1-034	34 C	52	44	95	34
DO3034-1-035	35 C	53	44	95	35
DO3034-1-036	36 C	54	44	95	36
DO3034-1-037	37 C	56	44	95	37
DO3034-1-038	38 C	57	44	95	38
DO3034-1-039	39 C	58	44	95	38
DO3034-1-040	40 C	58	44	95	38
DO3034-1-041	41 C	60	44	95	38
DO3034-1-042	42 C	62	44	95	38
DO3034-1-043	43 C	63	44	95	38
DO3034-1-044	44 C	65	44	95	38
DO3034-1-046	46 C	67	44	95	38
DO3034-1-047	47 C	68	44	95	38
DO3034-1-048	48 C	69	44	95	38
DO3034-1-049	49 C	70	44	95	38
DO3034-1-050	50 C	71	54	95	38
DO3034-1-052	52 C	74	54	95	40
DO3034-1-055	55 C	77	54	100	40
DO3034-1-060	60 C	84	54	105	42
DO3034-1-065	65 C	88	54	105	66

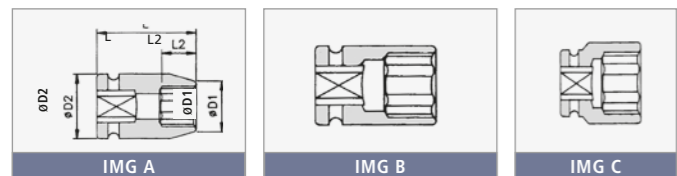

6-POINT DEEP 1

6-Kant tief
6-Pans profonde

Type	IMG	D1 mm	D2 mm	L mm	L2 mm	
SAE · Zoll · Pouce						
DO3034-1-13/16	13/16"	A	32	38	85	23
DO3034-1-7/8	7/8"	A	34	38	85	23
DO3034-1-15/16	15/16"	A	36	38	85	41
DO3034-1-1	1"	C	40	38	85	41
DO3034-1-1 1/8	1 1/8"	B	42	42	85	52
DO3034-1-1 3/16	1 3/16"	B	44	44	85	52
DO3034-1-1 1/4	1 1/4"	B	44	44	85	52
DO3034-1-1 5/16	1 5/16"	C	47	44	85	52
DO3034-1-1 7/16	1 7/16"	C	51	44	85	52
DO3034-1-1 1/2	1 1/2"	C	53	44	85	60

6-POINT EXTRA LONG 2

6-Kant extra lang
6-Pans extra longue

Type	IMG	D1 mm	D2 mm	L mm	L2 mm
Metrical · Metrisch · Metriques					
DO61145024	24 G	38,5	44	270	24
DO61145027	27 G	42	44	270	27
DO61145030	30 G	45	44	270	30
DO61145032	32 G	47	44	270	32
DO61145033	33 G	48	44	270	32
DO61145036	36 G	53,5	44	270	32

DO61146024	24 G	38,5	44	400	24
DO61146027	27 G	42	44	400	27
DO61146030	30 G	45	44	400	30
DO61146032	32 G	47	44	400	32
DO61146033	33 G	48	44	400	32
DO61146036	36 G	53,5	44	400	32

PIN AND RING

Ring und Stift
Joint torique clavette

DO1034-0-000

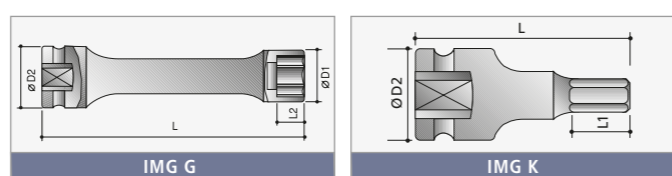

3/4" DRIVE | ANTRIEB | CARRÉ D'ENTRAÎNEMENT

6-POINT THIN WALL DEEP 1

6-Kant dünnwandig tief
6-Pans paroi mince profonde

Type	IMG	D1 mm	D2 mm	L mm	L2 mm
Metrical · Metrisch · Metriques					
DO61141017	17 A	25,5	44	95	17
DO61141019	19 A	28,5	44	95	19
DO61141022	22 A	33,5	44	95	22
DO61141024	24 A	36,5	44	95	24
DO61141027	27 A	40,5	44	95	27
DO61141030	30 A	43,5	44	95	30
DO61141032	32 B	46,5	44	95	32
DO61141033	33 B	47,5	44	95	33
DO61141035	35 B	51	44	95	35
DO61141036	36 B	52	44	95	36
DO61141038	38 B	54	44	95	38
DO61141041	41 B	57	44	95	38

Thin wall sockets are not covered by the Action warranty.

6-POINT EXTREME THIN WALL DEEP 1

6-Kant extrem dünnwandig tief
6-Pans extreme paroi mince profonde

Type	IMG	D1 mm	D2 mm	L mm	L2 mm
Metrical					
DO61142027	27 A	40	43	108	43
DO61142032	32 B	45	45	108	43
DO61142041	41 C	54,5	45	108	43

Thin wall sockets are not covered by the Action warranty.

HEX DRIVER 6-POINT (INBUS) 2

Außen 6-Kant (Inbus)
Empreinte 6-Pans (Inbus)

Type	IMG	D2 mm	L mm	L1 mm	-
Metrical · Metrisch · Metriques					
DO696510A	10 K	44	100	20	-
DO696512A	12 K	44	100	20	-
DO696514A	14 K	44	100	20	-
DO696517A	17 K	44	100	20	-
DO696519A	19 K	44	100	20	-
DO696522A	22 K	44	100	20	-
DO696524A	24 K	44	100	20	-
DO696527A	27 K	44	100	20	-
DO696530A	30 K	44	100	20	-
DO696532A	32 K	44	100	20	-
DO696536A	36 K	44	100	20	-

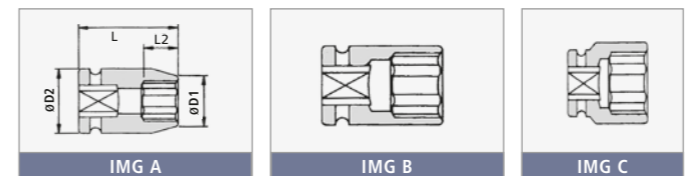

8-POINT 3

8-Kant
8-Pans

Type	IMG	D1 mm	D2 mm	L mm	L2 mm
Metrical · Metrisch · Metriques					
DO63645019	19 B	41	41	52	15
DO63645024	24 C	46	44,5	52	20
DO63645027	27 C	53	44,5	56	24
DO63645030	30 C	60	44,5	60	28
DO63645032	32 C	60	44,5	60	28
DO63645038	38 C	70	44,5	64	32

12-POINT NORMAL 4

12-Kant normal
12-Pans normale

Type	IMG	D1 mm	D2 mm	L mm	L2 mm
Metrical · Metrisch · Metriques					
DO63845013	13 A	24,5	44	50	9
DO63845014	14 A	25,5	44	50	11
DO63845015	15 A	27	44	50	11
DO63845016	16 A	28	44	50	11
DO63845017	17 A	31	44	50	12
DO63845018	18 A	32	44	50	13
DO63845019	19 A	33	44	50	155
DO63845020	20 A	34	44	50	14
DO63845021	21 A	35	44	50	15
DO63845022	22 A	37	44	50	15
DO63845023	23 A	38	44	50	16
DO63845024	24 A	39	44	50	18
DO63845025	25 B	41	44	50	18
DO63845026	26 C	42	44	50	18
DO63845027	27 C	43	44	54	19
DO63845028	28 C	44	44	54	19
DO63845029	29 C	45	44	54	21
DO63845030	30 C	47	44	54	21
DO63845031	31 C	48	44	56	21
DO63845032	32 C	49	44	56	22
DO63845033	33 C	51	44	56	22
DO63845034	34 C	52	44	56	22
DO63845035	35 C	53	44	56	22
DO63845036	36 C	54	44	56	25
DO63845037	37 C	56	44	58	25
DO63845038	38 C	57	44	58	25
DO63845039	39 C	58	44	58	25
DO63845041	41 C	60	44	58	27
DO63845042	42 C	62	44	58	27
DO63845043	43 C	63,5	44	63	27
DO63845046	46 C	67	44	63	30
DO63845050	50 C	71	54	72	32
DO63845055	55 C	77	54	74	35
DO63845056	56 C	78	54	74	35
DO63845060	60 C	84	54	75	37



1" IMPACT SOCKETS | 1" KRAFTSTECKSCHLÜSSEL | 1" DOUILLES À CHOC

3/4" DRIVE | ANTRIEB | CARRÉ D'ENTRAÎNEMENT

12-POINT NORMAL (CONTINUED) 1

12-Kant normal
12-Pans normale

Type	IMG	D1 mm	D2 mm	L mm	L2 mm
Metrical · Metrisch · Metriques					
DO63845063	63 C	87	54	75	37
DO63845065	65 C	90	54	78	40
DO63845067	67 C	92	54	80	40
DO63845070	70 C	96	54	80	40

12-POINT DEEP 2

12-Kant tief
12-Pans profonde

Type	IMG	D1 mm	D2 mm	L mm	L2 mm
Metrical · Metrisch · Metriques					
DO65847013	13 A	24,5	44	95	13
DO65847014	14 A	25,5	44	95	14
DO65847015	15 A	27	44	95	15
DO65847016	16 A	28	44	95	16
DO65847017	17 A	31	44	95	17
DO65847018	18 A	32	44	95	18
DO65847019	19 A	33	44	95	19
DO65847020	20 A	34	44	95	20
DO65847021	21 A	35	44	95	21
DO65847022	22 A	37	44	95	22
DO65847023	23 A	38	44	95	23
DO65847024	24 A	39	44	95	24
DO65847025	25 A	41	44	95	25
DO65847026	26 A	42	44	95	26
DO65847027	27 A	43	44	95	27
DO65847028	28 B	44	44	95	28
DO65847029	29 C	45	44	95	29
DO65847030	30 C	47	44	95	30
DO65847031	31 C	48	44	95	31
DO65847032	32 C	49	44	95	32
DO65847033	33 C	51	44	95	33
DO65847034	34 C	52	44	95	34
DO65847035	35 C	53	44	95	35
DO65847036	36 C	54	44	95	36
DO65847037	37 C	56	44	95	37
DO65847038	38 C	57	44	95	38
DO65847039	39 C	58	44	95	38
DO65847040	40 C	59	44	95	38
DO65847041	41 C	60	44	95	38
DO65847042	42 C	62	44	95	38
DO65847043	43 C	63,5	44	95	38
DO65847044	44 C	64,5	44	95	38
DO65847045	45 C	65,5	44	95	38
DO65847046	46 C	67	44	100	38
DO65847047	47 C	68	44	100	38
DO65847048	48 C	69	44	100	38

12-POINT DEEP (CONTINUED) 2

12-Kant tief
12-Pans profonde

Type	IMG	D1 mm	D2 mm	L mm	L2 mm
Metrical · Metrisch · Metriques					
DO65847049	49 C	70	44	100	38
DO65847050	50 C	71	54	100	38
DO65847051	51 C	72	54	100	40
DO65847052	52 C	74	54	100	40
DO65847053	53 C	75	54	100	40
DO65847054	54 C	77	54	100	40
DO65847055	55 C	78	54	105	40
DO65847056	56 C	79	54	105	40
DO65847057	57 C	80	54	105	40
DO65847058	58 C	81	54	105	40
DO65847060	60 C	84	54	105	42
DO65847063	63 C	87	54	105	42
DO65847065	65 C	90	54	105	66
DO65847067	67 C	92	54	105	66
DO65847068	68 C	94	54	105	66
DO65847070	70 C	96	54	105	66
DO65847073	73 C	100	54	108	66
DO65847075	75 C	102	64	108	68

TORX® INTERNAL 3

Torx® intern
Torx® intérieure

Type	IMG	D mm	L mm	L1 mm
DO64742050	T50 F	44	100	5,0
DO64742055	T55 F	44	100	5,5
DO64742060	T60 F	44	100	8,0
DO64742070	T70 F	44	100	9,4
DO64742080	T80 F	44	100	10,5
DO64742090	T90 F	44	100	11,8
DO64742100	T100 F	44	100	13,1

Torx® is a trademark of Textron.

TORX® EXTERNAL 4

Torx® extern
Torx® extérieure

Type	IMG	D1 mm	D2 mm	L mm	L2 mm
DO63340018	E18 A	25	44	56	12,5
DO63340020	E20 A	27	44	56	14
DO63340024	E24 A	33	44	56	16,5
DO63340032	E32 A	44	44	56	24,5

Torx® is a trademark of Textron.

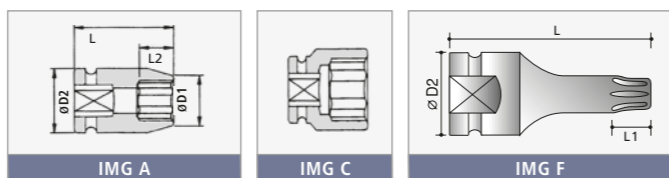



1" DRIVE | ANTRIEB | CARRÉ D'ENTRAÎNEMENT

4-POINT NORMAL 1

4-Kant normal
4-Pans normale

Type	IMG	D1 mm	D2 mm	L mm	L2 mm
Metrical · Metrisch · Metriques					
DO63055017	17 B	52	52	57	24
DO63055019	19 B	52	52	57	24
DO63055020	20 B	52	52	57	24
DO63055021	21 B	52	52	57	24

6-POINT NORMAL 2

6-Kant normal
6-Pans normale

Type	IMG	D1 mm	D2 mm	L mm	L2 mm
Metrical · Metrisch · Metriques					
DO4010-0-017	17 A	34	54	60	12
DO4010-0-018	18 A	35	54	60	13
DO4010-0-019	19 A	35,5	54	60	13
DO4010-0-020	20 A	37	54	60	14
DO4010-0-021	21 A	38	54	60	15
DO4010-0-022	22 A	40	54	60	15
DO4010-0-023	23 A	41	54	60	16
DO4010-0-024	24 A	42	54	60	18
DO4010-0-025	25 A	43	54	60	18
DO4010-0-026	26 A	44,5	54	60	18
DO4010-0-027	27 A	46	54	60	19
DO4010-0-028	28 A	47	54	62	19
DO4010-0-029	29 A	48	54	62	19
DO4010-0-030	30 A	50	54	62	21
DO4010-0-031	31 A	51	54	62	21
DO4010-0-032	32 A	52	54	62	22
DO4010-0-033	33 A	53	54	62	22
DO4010-0-034	34 C	55	54	62	22
DO4010-0-035	35 C	56	54	65	22
DO4010-0-036	36 C	57	54	67	25
DO4010-0-037	37 C	59	54	67	25
DO4010-0-038	38 C	59,5	54	67	25
DO4010-0-039	39 C	60	54	70	25
DO4010-0-040	40 C	62	54	70	25
DO4010-0-041	41 C	64	54	70	27
DO4010-0-042	42 C	65	54	74	27
DO4010-0-043	43 C	66	54	74	27
DO4010-0-045	45 C	68	54	74	27
DO4010-0-046	46 C	69,5	54	76	30
DO4010-0-047	47 C	72	54	76	32
DO4010-0-048	48 C	73	54	76	32
DO4010-0-050	50 C	74	54	80	35
DO4010-0-052	52 C	77	54	84	35

6-POINT NORMAL (CONTINUED) 2

6-Kant normal
6-Pans normale

Type	IMG	D1 mm	D2 mm	L mm	L2 mm
Metrical · Metrisch · Metriques					
DO4010-0-053	53 C	78	54	84	35
DO4010-0-054	54 C	79	54	84	35
DO4010-0-055	55 C	81	54	84	35
DO4010-0-056	56 C	83	54	84	40
DO4010-0-057	57 C	84	54	84	40
DO4010-0-058	58 C	85	54	87	40
DO4010-0-060	60 C	87	54	87	42
DO4010-0-062	62 C	89	54	87	42
DO4010-0-063	63 C	90	54	87	42
DO4010-0-065	65 C	93	54	90	42
DO4010-0-070	70 C	100	54	96	42
DO4010-0-075	75 C	106	86	98	45
DO4010-0-080	80 C	112	86	100	48
DO4010-0-085	85 C	118	86	105	52
DO4010-0-090	90 C	125	86	105	52
DO4010-0-095	95 C	131	86	115	52
DO4010-0-100	100 C	137	95	115	58
DO4010-0-105	105 C	143	95	115	58

6-POINT NORMAL 2

6-Kant normal
6-Pans normale

Type	IMG	D1 mm	D2 mm	L mm	L2 mm
SAE · Zoll · Pouce					
DO4010-0-1	1" A	42	51	58	18
DO4010-0-1 1/8	1 1/8" A	46	51	58	19
DO4010-0-1 5/16	1 5/16" C	53	52	62	21
DO4010-0-1 7/16	1 7/16" C	56	52	62	26
DO4010-0-1 1/2	1 1/2" C	58	52	62	26
DO4010-0-1 11/16	1 11/16" C	65	52	64	27
DO4010-0-1 7/8	1 7/8" C	70	58	66	28
DO4010-0-2 1/16	2 1/16" C	75	58	70	31
DO4010-0-2 1/4	2 1/4" C	84	62	75	34
DO4010-0-2 7/16	2 7/16" C	89	62	78	35
DO4010-0-2 1/2	2 1/2" C	91	62	80	36
DO4010-0-2 7/8	2 7/8" C	102	62	87	41

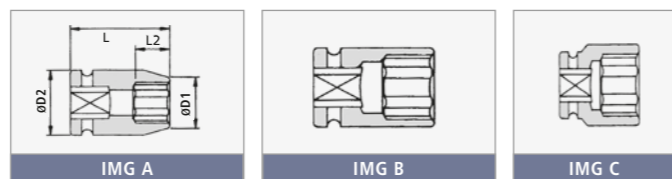

1" DRIVE | ANTRIEB | CARRÉ D'ENTRAÎNEMENT

6-POINT DEEP 2

6-Kant tief
6-Pans profunde

Type	IMG	D1 mm	D2 mm	L mm	L2 mm
Metrical · Metrisch · Metriques					
DO4010-1-017	17 A	34	54	100	17
DO4010-1-018	18 A	34	54	100	18
DO4010-1-019	19 A	35,5	54	100	19
DO4010-1-020	20 A	36,5	54	100	20
DO4010-1-021	21 A	37,5	54	100	21
DO4010-1-022	22 A	40	54	100	22
DO4010-1-023	23 A	41	54	100	23
DO4010-1-024	24 A	42	54	100	24
DO4010-1-025	25 A	43	54	100	25
DO4010-1-026	26 A	44,5	54	100	26
DO4010-1-027	27 A	46	54	100	27
DO4010-1-028	28 A	47	54	100	28
DO4010-1-029	29 A	48	54	100	29
DO4010-1-030	30 A	50	54	100	30
DO4010-1-031	31 A	51	54	100	31
DO4010-1-032	32 A	52	54	100	32
DO4010-1-033	33 A	53	53	100	33
DO4010-1-034	34 C	55	54	100	34
DO4010-1-035	35 C	56	54	100	35
DO4010-1-036	36 C	57	54	100	36
DO4010-1-037	37 C	57	54	100	37
DO4010-1-038	38 C	59,5	54	100	38
DO4010-1-039	39 C	61	54	100	38
DO4010-1-040	40 C	62	54	100	38
DO4010-1-041	41 C	64	54	100	38
DO4010-1-042	42 C	65	54	100	38
DO4010-1-046	46 C	69,5	54	100	38
DO4010-1-047	47 C	71,5	54	100	38
DO4010-1-048	48 C	72,5	54	100	38
DO4010-1-050	50 C	75	54	100	38
DO4010-1-054	54 C	80	54	100	40
DO4010-1-055	55 C	81	54	100	40
DO4010-1-056	56 C	82	54	105	40
DO4010-1-058	58 C	85	54	105	40
DO4010-1-060	60 C	87	54	120	42
DO4010-1-065	65 C	93	54	125	42
DO4010-1-070	70 C	100	54	125	42
DO4010-1-075	75 C	106	86	135	45
DO4010-1-080	80 C	112	86	135	48
DO4010-1-085	85 C	118	86	140	52
DO4010-1-090	90 C	125	86	140	52
DO4010-1-095	95 C	131	86	140	52
DO4010-1-100	100 C	137	95	140	58
DO4010-1-105	105 C	143	95	155	58
DO4010-1-110	110 C	149	95	155	60
DO4010-1-115	115 C	155	95	155	62

6-POINT DEEP 1

6-Kant tief
6-Pans profunde

Type	IMG	D1 mm	D2 mm	L mm	L2 mm
SAE · Zoll · Pouce					
DO4010-1-15/16	15/16" A	40	51	90	21
DO4010-1-1	1" A	42	51	90	25
DO4010-1-1 1/16	1 1/16" A	44	51	90	23
DO4010-1-1 3/16	1 3/16" A	48	51	90	40
DO4010-1-1 5/16	1 5/16" C	53	52	90	40
DO4010-1-1 1/2	1 1/2" C	58	52	92	54

6-POINT THIN WALL DEEP 1

6-Kant dünnwandige tief
6-Pans paroi mince profunde

Type	IMG	D1 mm	D2 mm	L mm	L2 mm
Metrical · Metrisch · Metriques					
DO61151019	19 A	33	54	100	19
DO61151024	24 A	38	54	100	24
DO61151027	27 A	42,5	54	100	27
DO61151028	28 A	43	54	100	28
DO61151030	30 A	45	54	100	30
DO61151032	32 A	47	54	100	32
DO61151033	33 A	49	54	100	33
DO61151036	36 A	52	54	100	36
DO61151041	41 C	57	54	100	38

6-POINT EXTRA DEEP 2

6-Kant extra tief
6-Pans extra profunde

Type	IMG	D1 mm	D2 mm	L mm	L2 mm
Metrical · Metrisch · Metriques					
DO60559024	24 B	42	54	270	24
DO60559026	26 B	44	54	270	26
DO60559027	27 B	45	54	270	27
DO60559030	30 B	50	54	270	30
DO60559032	32 B	52	54	270	32
DO60559033	33 B	52	54	270	32
DO6115H032	32 B	48,5	54	400	32

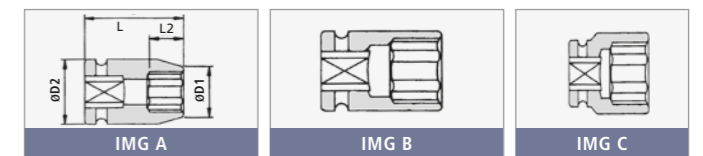



1" DRIVE | ANTRIEB | CARRÉ D'ENTRAÎNEMENT

8-POINT NORMAL 1

8-Kant normal
8-Pans normale

Type	IMG	D1 mm	D2 mm	L mm	L2 mm
Metrical · Metrisch · Metriques					
DO63655019	19 A	45	54	60	13
DO63655024	24 A	52	54	60	18
DO63655027	27 C	56,5	54	60	19
DO63655030	30 C	61	54	62	21
DO63655032	32 C	64	54	62	22
DO63655035	35 C	68,5	58	65	22
DO63655038	38 C	73	58	67	24
DO63655046	46 C	86	62	76	30

12-POINT NORMAL 2

12-Kant normal
12-Pans normale

Type	IMG	D1 mm	D2 mm	L mm	L2 mm
Metrical · Metrisch · Metriques					
DO65855016	16 A	32	54	60	11
DO65855017	17 A	34	54	60	12
DO65855018	18 A	35	54	60	13
DO65855019	19 A	36	54	60	13
DO65855020	20 A	37	54	60	14
DO65855021	21 A	38	54	60	15
DO65855022	22 A	39	54	60	15
DO65855023	23 A	40	54	60	16
DO65855024	24 A	41	54	60	18
DO65855025	25 A	43	54	60	18
DO65855026	26 A	44,5	54	60	18
DO65855027	27 A	45	54	60	19
DO65855028	28 A	46,5	54	62	19
DO65855029	29 A	48	54	62	19
DO65855030	30 A	50	54	62	21
DO65855031	31 A	51	54	62	21
DO65855032	32 A	52	54	62	22
DO65855033	33 A	53	54	62	22
DO65855034	34 C	55	54	62	22
DO65855035	35 C	56	54	65	22
DO65855036	36 C	57	54	67	25
DO65855037	37 C	59	54	67	25
DO65855038	38 C	60	54	67	25
DO65855039	39 C	61	54	70	25
DO65855040	40 C	62	54	70	25
DO65855041	41 C	63,5	54	70	27
DO65855042	42 C	65	54	74	27
DO65855043	43 C	66	54	74	27
DO65855044	44 C	67	54	74	27
DO65855045	45 C	68	54	74	27

12-POINT NORMAL (CONTINUED) 2

12-Kant normal
12-Pans normale

Type	IMG	D1 mm	D2 mm	L mm	L2 mm
Metrical · Metrisch · Metriques					
DO65855046	46 C	70	58	76	30
DO65855047	47 C	71,5	58	76	32
DO65855048	48 C	72,5	58	76	32
DO65855050	50 C	75	62	80	35
DO65855051	51 C	76	62	80	35
DO65855052	52 C	77	62	84	35
DO65855053	53 C	78	62	84	35
DO65855054	54 C	80	62	84	35
DO65855055	55 C	81	62	84	35
DO65855056	56 C	82	62	84	40
DO65855057	57 C	84	62	84	40
DO65855058	58 C	85	62	87	40
DO65855060	60 C	87	62	87	42
DO65855062	62 C	89	62	87	42
DO65855063	63 C	90	62	87	42
DO65855065	65 C	93	62	90	42
DO65855067	67 C	96	62	92	42
DO65855070	70 C	100	62	96	42
DO65855075	75 C	106	86	98	45
DO65855076	76 C	107	86	100	48
DO65855077	77 C	109	86	100	48
DO65855078	78 C	110	86	100	48
DO65855080	80 C	112	86	100	48
DO65855085	85 C	118	86	105	52
DO65855090	90 C	125	86	105	52
DO65855095	95 C	131	86	105	52
DO65855100	100 C	137	86	115	58
DO65855105	105 C	143	95	115	58
DO65855110	110 C	149	95	115	60
DO65855115	115 C	155	95	115	62

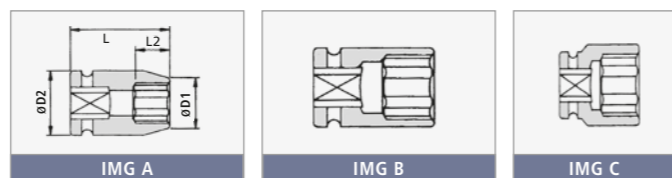

1" DRIVE | ANTRIEB | CARRÉ D'ENTRAÎNEMENT

12-POINT DEEP 1

12-Kant tief
12-Pans profunde

Type	IMG	D1 mm	D2 mm	L mm	L2 mm
Metrical · Metrisch · Metriques					
DO65857016	16 A	32	54	100	16
DO65857017	17 A	34	54	100	17
DO65857018	18 A	35	54	100	18
DO65857019	19 A	36	54	100	19
DO65857020	20 A	37	54	100	20
DO65857021	21 A	38	54	100	21
DO65857022	22 A	40	54	100	22
DO65857023	23 A	41	54	100	23
DO65857024	24 A	42	54	100	24
DO65857025	25 A	43	54	100	25
DO65857026	26 A	44,5	54	100	26
DO65857027	27 A	46	54	100	27
DO65857028	28 A	47	54	100	28
DO65857029	29 A	48	54	100	29
DO65857030	30 A	50	54	100	30
DO65857031	31 A	51	54	100	31
DO65857032	32 A	52	54	100	32
DO65857033	33 A	53	54	100	33
DO65857034	34 C	55	54	100	34
DO65857035	35 C	56	54	100	35
DO65857036	36 C	57	54	100	36
DO65857037	37 C	59	54	100	37
DO65857038	38 C	60	54	100	38
DO65857039	39 C	61	54	100	38
DO65857040	40 C	62	54	100	38
DO65857041	41 C	63	54	100	38
DO65857042	42 C	65	54	100	38
DO65857043	43 C	66	54	100	38
DO65857044	44 C	67	54	100	38
DO65857045	45 C	68	54	100	38
DO65857046	46 C	70	58	100	38
DO65857047	47 C	71,5	58	100	38
DO65857048	48 C	72,5	58	100	38
DO65857050	50 C	75	62	100	38
DO65857051	51 C	76	62	100	40
DO65857052	52 C	77	62	100	40
DO65857053	53 C	78	62	100	40
DO65857054	54 C	80	62	100	40
DO65857055	55 C	81	62	100	40
DO65857056	56 C	82	62	105	40
DO65857057	57 C	84	62	105	40
DO65857058	58 C	85	62	105	40
DO65857060	60 C	87	62	120	42
DO65857062	62 C	89	62	120	42
DO65857063	63 C	90	62	120	42
DO65857065	65 C	93	62	125	42
DO65857067	67 C	96	62	125	42
DO65857070	70 C	100	62	125	42

12-POINT DEEP (CONTINUED) 1

12-Kant tief
12-Pans profunde

Type	IMG	D1 mm	D2 mm	L mm	L2 mm
Metrical · Metrisch · Metriques					
DO65857075	75 C	106	86	135	45
DO65857076	76 C	107	86	135	48
DO65857077	77 C	109	86	135	48
DO65857078	78 C	110	86	135	48
DO65857080	80 C	112	86	135	48
DO65857085	85 C	118	86	140	52
DO65857090	90 C	125	86	140	52
DO65857095	95 C	131	86	140	52
DO65857100	100 C	137	86	140	58
DO65857105	105 C	143	95	155	58
DO65857110	110 C	149	95	155	60
DO65857115	115 C	155	95	155	62

HEX DRIVER 6-POINT (INBUS) 2

Außen-6-Kant (Inbus)
Empreinte 6-pans (inbus)

Type	IMG	D2 mm	L mm	L1 mm	-
Metrical · Metrisch · Metriques					
DO696610A	10 K	54	100	20	-
DO696612A	12 K	54	100	20	-
DO696614A	14 K	54	100	20	-
DO696617A	17 K	54	100	20	-
DO696619A	19 K	54	100	20	-
DO696622A	22 K	54	100	20	-
DO696622B	22 K	54	140	20	-
DO696624A	24 K	54	100	20	-
DO696627A	27 K	54	100	20	-
DO696630A	30 K	54	100	24	-
DO696632A	32 K	54	100	24	-
DO696636A	36 K	54	100	28	-

PIN AND RING

Ring und Stift
Joint torique clavette

Type	D2 mm
DO1100-0-000	54
DO1100-0-086	86
DO1100-0-095	95





1 1/2" DRIVE | ANTRIEB | CARRÉ D'ENTRAÎNEMENT

6-POINT NORMAL 1

6-Kant normal
6-Pans normale

Type	mm	IMG	D1 mm	D2 mm	L mm	L2 mm
------	----	-----	-------	-------	------	-------

Metrical · Metrisch · Metriques

DO5112-0-030	30	A	56	86	78	21
DO5112-0-032	32	A	58	86	78	22
DO5112-0-035	35	A	62	86	78	22
DO5112-0-036	36	A	64	86	78	24
DO5112-0-037	37	A	65	86	78	24
DO5112-0-038	38	A	66	86	78	26
DO5112-0-040	40	A	68	86	78	28
DO5112-0-041	41	A	70	86	80	28
DO5112-0-045	45	A	75	86	84	30
DO5112-0-046	46	A	76	86	84	30
DO5112-0-047	47	A	77	86	84	32
DO5112-0-048	48	A	79	86	84	32
DO5112-0-050	50	A	81	87	87	32
DO5112-0-052	52	A	83	86	87	34
DO5112-0-054	54	B	86	86	90	37
DO5112-0-055	55	B	86	86	90	37
DO5112-0-056	56	B	86	86	92	37
DO5112-0-058	58	C	92	86	92	39
DO5112-0-060	60	C	93	86	92	39
DO5112-0-061	61	C	95	86	95	42
DO5112-0-062	62	C	96	86	95	42
DO5112-0-065	65	C	97	86	95	42
DO5112-0-068	68	C	104	86	100	46
DO5112-0-070	70	C	105	86	100	46
DO5112-0-072	72	C	108	86	108	49
DO5112-0-075	75	C	110	86	108	49
DO5112-0-078	78	C	115	86	115	53
DO5112-0-080	80	C	116	86	115	53
DO5112-0-085	85	C	125	86	118	56
DO5112-0-090	90	C	130	86	123	59
DO5112-0-095	95	C	137	95	123	62
DO5112-0-100	100	C	140	95	130	65
DO5112-0-105	105	C	150	95	130	68
DO5112-0-110	110	C	156	95	135	72
DO5112-0-115	115	C	160	95	140	77
DO5112-0-125	125	C	175	127	140	77

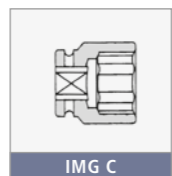
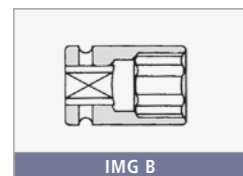
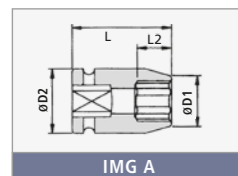

6-POINT DEEP 2

6-Kant tief
6-Pans profonde

Type	mm	IMG	D1 mm	D2 mm	L mm	L2 mm
------	----	-----	-------	-------	------	-------

Metrical · Metrisch · Metriques

DO5112-1-036	36	A	64	86	115	24
DO5112-1-041	41	A	70	86	115	28
DO5112-1-042	42	A	71	86	115	28
DO5112-1-046	46	A	76	86	115	30
DO5112-1-050	50	A	81	86	135	34
DO5112-1-054	54	B	86	86	140	37
DO5112-1-055	55	B	86	86	140	37
DO5112-1-056	56	B	88	86	140	37
DO5112-1-060	60	C	94	86	150	39
DO5112-1-063	60	C	97	86	150	42
DO5112-1-065	65	C	100	86	150	42
DO5112-1-070	70	C	106	86	160	46
DO5112-1-075	75	C	112	86	170	49
DO5112-1-080	80	C	119	86	170	53
DO5112-1-085	85	C	125	86	170	56
DO5112-1-090	90	C	131	86	170	59
DO5112-1-095	95	C	137	95	180	61
DO5112-1-100	100	C	144	95	190	65
DO5112-1-105	105	C	154	95	190	68
DO5112-1-110	110	C	157	95	200	72
DO5112-1-115	115	C	164	95	210	77
DO5112-1-120	120	C	167	95	210	77
DO5112-1-125	125	C	174	127	210	77

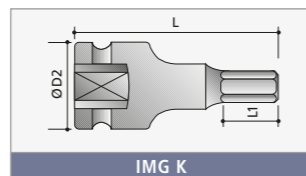

1 1/2" DRIVE | ANTRIEB | CARRÉ D'ENTRAÎNEMENT

HEX DRIVER 6-POINT (INBUS) 1

Außen-6-Kant (Inbus)
Empreinte 6-pans (inbus)

Type	mm	IMG	D2mm	L mm	L1 mm	-
------	----	-----	------	------	-------	---

Metrical · Metrisch · Metriques

DO64866019	19	K	86	105	20	-
DO64866022	22	K	86	105	20	-
DO64866024	24	K	86	105	20	-
DO64866027	27	K	86	105	20	-
DO64866030	30	K	86	105	20	-
DO64866032	32	K	86	105	20	-
DO64866033	33	K	86	105	20	-
DO64866041	41	K	86	105	20	-
DO64866046	46	K	86	105	20	-
DO64866050	50	K	86	105	20	-
DO64866055	55	K	86	105	20	-
DO64865019	19	K	86	120	20	-
DO64865022	22	K	86	120	20	-
DO64865024	24	K	86	120	20	-
DO64865027	27	K	86	120	20	-
DO64865030	30	K	86	120	24	-
DO64865032	32	K	86	120	24	-
DO64865033	33	K	86	120	24	-
DO64865036	36	K	86	120	28	-
DO64865038	38	K	86	120	28	-
DO64865041	41	K	86	120	34	-
DO64865046	46	K	86	120	38	-
DO64865050	50	K	86	120	38	-
DO64865055	55	K	86	120	43	-

PIN AND RING

Ring und Stift
Joint torique clavette



Type	D2 mm
DO1112-0-000	86
DO1112-0-095	95
DO1112-0-127	127

2 1/2" DRIVE | ANTRIEB | CARRÉ D'ENTRAÎNEMENT

6-POINT NORMAL 2

6-Kant normal
6-Pans normale

Type	mm	IMG	D1 mm	D2 mm	L mm	L2 mm
------	----	-----	-------	-------	------	-------

Metrical · Metrisch · Metriques

DO6212-0-060	60	A	99	127	125	37
DO6212-0-065	65	A	105	127	130	40
DO6212-0-070	70	A	110	127	130	40
DO6212-0-075	75	A	118	127	140	42
DO6212-0-077	77	A	122	127	140	45
DO6212-0-080	80	A	124	127	140	45
DO6212-0-085	85	C	130	127	140	52
DO6212-0-090	90	C	136	127	145	52
DO6212-0-095	95	C	143	127	145	52
DO6212-0-100	100	C	149	127	150	58
DO6212-0-105	105	C	155	127	155	58
DO6212-0-110	110	C	161	127	160	60
DO6212-0-115	115	C	167	127	165	62
DO6212-0-120	120	C	176	127	170	67
DO6212-0-125	125	C	184	127	175	72
DO6212-0-130	130	C	188	152	175	72
DO6212-0-135	135	C	195	152	180	77
DO6212-0-140	140	C	204	152	180	77
DO6212-0-145	145	C	207	152	185	83
DO6212-0-150	150	C	214	152	185	83
DO6212-0-155	155	C	224	152	190	90
DO6212-0-160	160	C	227	152	190	90
DO6212-0-165	165	C	234	152	195	95
DO6212-0-170	170	C	244	152	195	95
DO6212-0-175	175	C	247	152	200	100
DO6212-0-180	180	C	254	152	200	100
DO6212-0-185	185	C	257	152	210	105
DO6212-0-190	190	C	265	152	210	105
DO6212-0-200	200	C	275	152	220	110

PIN AND RING

Ring und Stift
Joint torique clavette



DO2112-0-000

EXTENSIONS | VERLÄNGERUNGEN | RALLONGES

EXTENSION BARS WITH PIN HOLE
Verlängerungen mit Stiftloch
Rallonges à cliquet femelle

1

Type	IMG	D mm	L mm
Metrical · Metrisch · Metriques			
DO7014-0-050	1/4"	B	13
DO7014-0-100	1/4"	B	13
DO7014-0-150	1/4"	B	13
DO7038-0-075	3/8"	B	19
DO7038-0-100	3/8"	B	19
DO7038-0-125	3/8"	B	19
DO7038-0-150	3/8"	B	19
DO7038-0-200	3/8"	B	19
DO7038-0-250	3/8"	B	19
DO7012-0-075	1/2"	B	25
DO7012-0-100	1/2"	B	25
DO7012-0-125	1/2"	B	25
DO7012-0-150	1/2"	B	25
DO7012-0-175	1/2"	B	25
DO7012-0-200	1/2"	B	25
DO7012-0-250	1/2"	B	25
DO7012-0-300	1/2"	B	25
DO7012-0-460	1/2"	B	25
DO7012-0-610	1/2"	B	25
DO7012-0-915	1/2"	B	25
DO7034-0-075	3/4"	B	44
DO7034-0-100	3/4"	B	44
DO7034-0-125	3/4"	B	44
DO7034-0-150	3/4"	B	44
DO7034-0-175	3/4"	B	44
DO7034-0-200	3/4"	B	44
DO7034-0-250	3/4"	B	44
DO7034-0-330	3/4"	B	44
DO7034-0-400	3/4"	B	44
DO7100-0-075	1"	B	54
DO7100-0-100	1"	B	54
DO7100-0-125	1"	B	54
DO7100-0-150	1"	B	54
DO7100-0-175	1"	B	54
DO7100-0-200	1"	B	54
DO7100-0-250	1"	B	54
DO7100-0-300	1"	B	54
DO7100-0-330	1"	B	54
DO7100-0-350	1"	B	54
DO7100-0-400	1"	B	54
DO7112-0-125	1 1/2"	B	86
DO7112-0-250	1 1/2"	B	86
DO7112-0-500	1 1/2"	B	86
DO7212-0-250	2 1/2"	B	127
DO7212-0-500	2 1/2"	B	127

Pin and rings are not standard on the extension bar with pin hole.
Ring und Stift werden bei den Verlängerungen mit Stiftloch nicht mitgeliefert.
Les joints toriques clavettes ne sont pas livrés en standard avec les adaptateurs.
PLEASE ORDER SEPERATELY | BITTE SEPERAT BESTELLEN | A COMMANDER SÉPARÉMENT

EXTENSION BARS WITH STEEL BALL
Verlängerungen mit Kugelsicherung
Rallonges à cliquet bille d'acier

2

Type	IMG	D2 mm	L mm
Metrical · Metrisch · Metriques			
DO6862075	3/8"	A	19
DO6862100	3/8"	A	19
DO6862125	3/8"	A	19
DO6862150	3/8"	A	19
DO6862250	3/8"	A	19
DO6863075	1/2"	A	25
DO6863100	1/2"	A	25
DO6863125	1/2"	A	25
DO6863250	1/2"	A	25

EXTENSION BARS WITH LOCK PIN RETAINER
Verlängerungen mit Sicherungsstift
Rallonges à cliquet mâle

3

Type	IMG	D2 mm	L mm
Metrical · Metrisch · Metriques			
DO64514075	3/8"	A	19
DO64514100	3/8"	A	19
DO64514125	3/8"	A	19
DO64514150	3/8"	A	19
DO64514200	3/8"	A	19
DO64514250	3/8"	A	19
DO64514400	3/8"	A	19
DO64524075	1/2"	A	25
DO64524100	1/2"	A	25
DO64524125	1/2"	A	25
DO64524150	1/2"	A	25
DO64524200	1/2"	A	25
DO64524460	1/2"	A	25

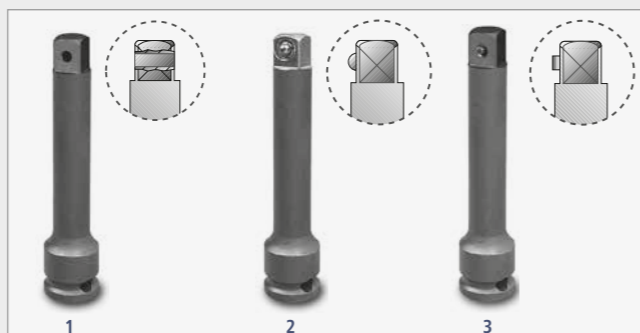
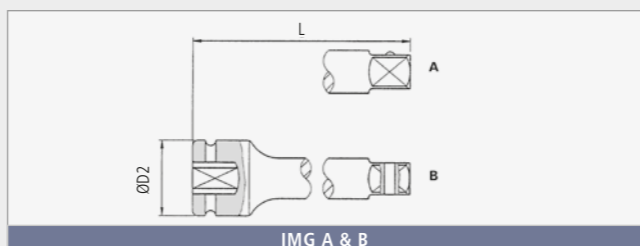

PINHOLE Stiftloch Rallonges à cliquet femelle
STEEL BALL RETAINER Kugelsicherung Rallonges à cliquet bille d'acier
LOCK PIN RETAINER Sicherungsstift Rallonges à cliquet mâle

WOBBLE EXTENSION BARS | VERLÄNGERUNG WOBBLE | RALLONGES WOBBLE

WOBBLE EXTENSION BARS
Verlängerung Wobble
Rallonges Wobble

Type	IMG	D2 mm	L mm	Type
Metrical · Metrisch · Metriques				
DO6450F050	1/4"	1/4"	13	50
DO6450F075	1/4"	1/4"	13	75
DO6450F100	1/4"	1/4"	13	100
DO6451F050	3/8"	3/8"	19	50
DO6451F075	3/8"	3/8"	19	75
DO6451F100	3/8"	3/8"	19	100
DO6451F200	3/8"	3/8"	19	200
DO6452F075	1/2"	1/2"	25	75
DO6452F125	1/2"	1/2"	25	125
DO6452F150	1/2"	1/2"	25	150
DO6452F200	1/2"	1/2"	25	200

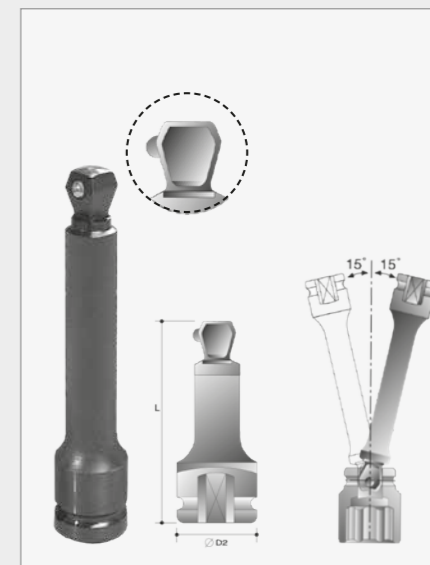

UNIVERSAL JOINTS | KUGELGELENKE | CARDANS

UNIVERSAL JOINTS WITH STEEL BALL
Kugelgelenke mit Kugelsicherung
Cardans à cliquet mâle

Type	IMG	D2 mm	L mm
Metrical · Metrisch · Metriques			
DO6781F1T	1/4"	1/4"	A
DO6782F2T	3/8"	3/8"	A
DO6783F3T	1/2"	1/2"	A
DO6784F4T	3/4"	3/4"	A



UNIVERSAL JOINTS WITH PIN HOLE
Kugelgelenke mit Stiftloch
Cardans à cliquet femelle

Type	IMG	D2 mm	L mm
Metrical · Metrisch · Metriques			
DO9014-0-000	1/4"	1/4"	B
DO9038-0-000	3/8"	3/8"	B
DO9012-0-000	1/2"	1/2"	B
DO9034-0-000	3/4"	3/4"	B
DO9100-0-000	1"	1"	B
DO9112-0-000	1 1/2"	1 1/2"	B



Pin and rings are not standard on the universal joints with pin hole.
Ring und Stift werden bei den Kugelgelenken mit Stiftloch nicht mitgeliefert.
Les joints toriques clavettes ne sont pas livrés en standard avec les adaptateurs à cliquet.
PLEASE ORDER SEPERATELY | BITTE SEPERAT BESTELLEN | A COMMANDER SÉPARÉMENT

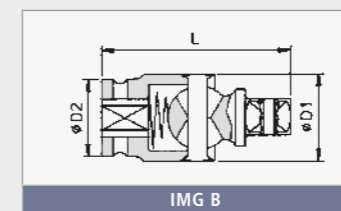
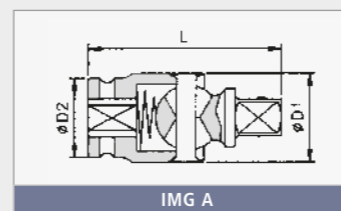

IMPACT ADAPTORS
VERBINDUNGSTEIL MIT AUSSENVIERKANT
ADAPTEURS D'IMPACT

Type	IMG	L mm	D mm
Metrical · Metrisch · Metriques			
DO69306050	1/4"	1/4"	C
DO69306075	1/4"	1/4"	C
DO69306100	1/4"	1/4"	C
DO69306150	1/4"	1/4"	C
DO69316050	3/8"	1/4"	C
DO69316075	3/8"	1/4"	C
DO69316100	3/8"	1/4"	C
DO69318075	3/8"	7/16"	D
DO6932E050	1/2"	1/4"	C
DO69328075	1/2"	7/16"	D

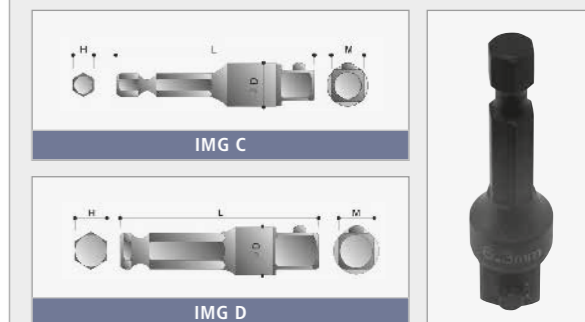

ADAPTORS | REDUZIERSTÜCKE | ADAPTATEURS

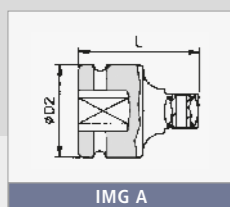

ADAPTORS WITH PIN HOLE
Reduzierstücke mit Stiftloch
Adaptateurs à cliquet femelle



Type	IMG	D2 mm	L mm
SAE - Zoll - Pouce			
DO8014-0-038	1/4" 3/8"	A 13	26
DO8038-0-014	3/8" 1/4"	A 22	32
DO8038-0-012	3/8" 1/2"	A 22	36
DO8012-0-034	1/2" 3/4"	A 30	48
DO8012-0-038	1/2" 3/8"	A 26	38
DO8034-0-012	3/4" 1/2"	A 40	58
DO8034-0-100	3/4" 1"	A 40	63
DO8100-0-034	1" 3/4"	A 52	80
DO8100-0-112	1" 1 1/2"	A 52	91
DO8112-0-100	1 1/2" 1"	A 84	95
DO8112-0-212	1 1/2" 2 1/2"	A 86	120
DO8134-0-112	1 3/4" 1 1/2"	A 127	153
DO8212-0-112	2 1/2" 1 1/2"	A 127	138

ADAPTOR WITH STEEL BALL
Reduzierstücke mit Kugelsicherung
Adaptateurs à cliquet male



Type	IMG	D2 mm	L mm
SAE - Zoll - Pouce			
DO64001012	1/4" 3/8"	A 13,6	26
DO64011008	3/8" 1/4"	A 22	32
DO6822F3T	3/8" 1/2"	A 22	36
DO6823F2T	1/2" 3/8"	A 25	38
DO64021024	1/2" 3/4"	A 30	48
DO6815L3T	3/4" 1/2"	A 44	56
DO64051024	1" 3/4"	A 54	75

RETRING | FEDERRING | ANNEAU DE RETENUE



Typ	D2 mm	Bit
DO10032S	36,5	3/4"
DO18708S	44,5	3/4"
DO18715S	53,9	3/4" & 1"
DO10008S	44,5	1"
DO10021S	76,2	1 1/2"
DO10025S	85,7	1 1/2"



STEP 1
Place Socket Retainer over square driver. Place socket on square driver aligning retention holes. Hold center pin of Retainer between thumb and index finger, and insert it through retention holes.

Setzen Sie den Federring über den Antriebsvierkant. Setzen Sie die Kraftstecknuss in Richtung der Haltelöcher. Halten Sie den Mittelstift des Federrings zwischen Daumen und Zeigefinger und stecken ihn durch das Halteloch.

Placez l'anneau de retenue sur le carré d'entraînement. Mettez la douille sur le carré en alignant les trous de retenue.



STEP 2
Push center pin of Socket Retainer all the way in.

Stecken Sie den Mittelstift ganz durch.

Prenez la tige de retenue entre le pouce et l'index et entrez la au travers des trous.



STEP 3
Pull O-ring of Socket Retainer up into groove Socket.

Ziehen Sie den O-Ring des Federrings hoch in die Nut des Kraftsteckschlüssels.

Tirer le joint torique maintenant à l'endroit désiré.

MAGNETIC REDUCING ADAPTORS | MAGNETISCHE REDUZIERSTÜCKE | ADAPTATEURS MAGNÉTIQUE

Type	Form	D2 mm	L mm
SAE - Zoll - Pouce			
DO69880P12	A	19	17
DO69880P16	A	25	22
DO69881P16	A	25	22
DO69881P20	A	35	23
DO69882P24	A	44	30
DO69884P32	B	54	35
DO69885P48	B	86	50
DO69886P80	B	127	59
DO69888P01	B	176	95

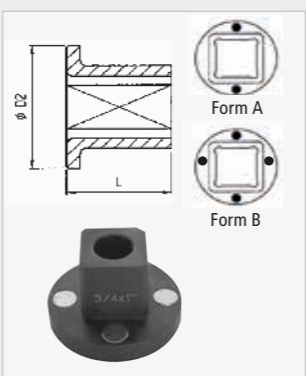

The magnetic sleeve adaptors allow the temporary use of bigger impact sockets on smaller tools. By means of the magnet, chances of loosing the adaptor are reduced. Especially well suited for the service kit of the travelling mechanic, doing the service to heavy equipment.

Die reduzierende Hülse ermöglicht die Verwendung größerer Kraftsteckschlüssel auf kleinerem Schlagschrauber. Der Magnet sorgt dafür, dass der Adapter den Kraftsteckschlüssel hält. Dieses Set ist ideal für die Toolbox des reisenden Servicetechnikers, bei Wartung und Reparaturen an zum Beispiel schweren Baumaschinen.

QUICK-CHANGE ADAPTORS | SCHNELLWECHSELHALTER | ADAPTATEURS À CHANGEMENT RAPIDE



QUICK-CHANGE ADAPTORS
Schnellwechselhalter
Adaptateurs à changement rapide

Type	IMG	D2 mm	L mm
SAE - Zoll - Pouce			
DO69110C08	A 1/4" 1/4"	13	35
DO69111C12	A 3/8" 3/8"	19	46
DO69111C16	A 3/8" 1/2"	22	60
DO69112C12	A 1/2" 3/8"	25	54
DO69112C16	A 1/2" 1/2"	25	60
DO69114C16	A 3/4" 1/2"	44	70
DO69114C24	A 3/4" 3/4"	44	78
DO69115C24	A 1" 3/4"	54	90
DO69115C32	A 1" 1"	54	100
DO69115C64	A 1" 3/4"	54	300

BITHOLDER
Schnellwechselhalter
Adaptateurs à changement rapide

Type	IMG	D2 mm	L mm	Bit-shape
SAE - Zoll - Pouce				
DO69111A14	B 3/8" 7/16"	22	51	E
DO69112A14	B 1/2" 7/16"	25	54	E

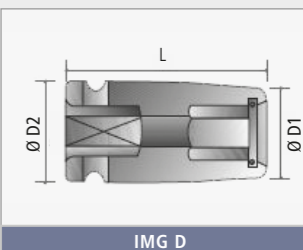
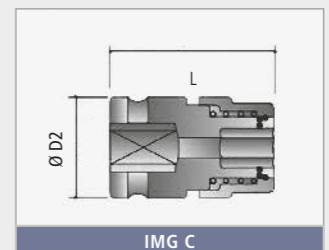
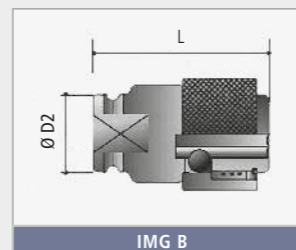
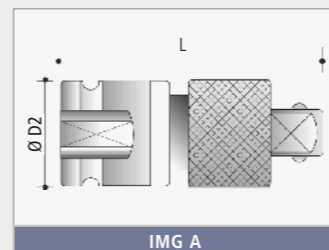

BITHOLDER
Schnellwechselhalter
Adaptateurs à changement rapide

Type	IMG	D2 mm	L mm	Bit-shape
SAE - Zoll - Pouce				
DO69121B08	C 3/8" 1/4"	19	33	C
DO69122B08	C 1/2" 1/4"	25	41	C

IMPACT BIT HOLDER
Adapter Antriebs-4K auf Bithalter (6K)
Mandrins à chocs

Type	IMG	D1 mm	D2 mm	L mm	Bit-shape
SAE - Zoll - Pouce					
DO69121008	D 3/8" 1/4"	12,5	19	32	C
DO69121010	D 3/8" 5/16"	14	19	37	C
DO69121016	D 3/8" 1/2"	19	19	37	C
DO69122008	D 1/2" 1/4"	12,5	25	40	C
DO69122010	D 1/2" 5/16"	15,5	25	40	C
DO69122016	D 1/2" 1/2"	20	25	40	C

QUICK-CHANGE ADAPTORS | SCHNELLWECHSELHALTER | ADAPTATEURS À CHANGEMENT RAPIDE

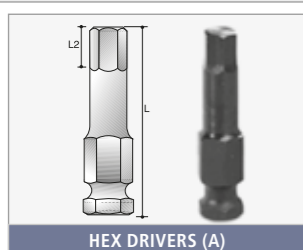

HEX DRIVERS (A)

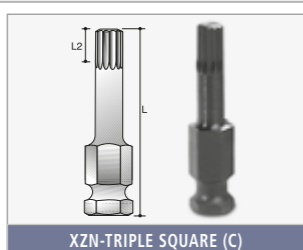

XZN-TRIPLE SQUARE (C)

HEX DRIVERS - 7/16"
Sechskantbits - 7/16"
Embouts Hexagonal - 7/16"

Type	IMG	Size Gewinde Taille	L2 mm	L mm
------	-----	---------------------	-------	------

Metrical · Metrisch · Métriques

DO697RG606	7/16"	A	6	6	60
DO697RG608	7/16"	A	8	8	60
DO697RG610	7/16"	A	10	10	60
DO697RG612	7/16"	A	12	10	60
DO697RG614	7/16"	A	14	10	60
DO697RG617	7/16"	A	17	10	60

TRIPLE SQUARE BITS - 7/16"
XZN Bits - 7/16"
Embouts Carre Triple - 7/16"

Type	IMG	Size Gewinde Taille	L2 mm	L mm
------	-----	---------------------	-------	------

Metrical · Metrisch · Métriques

DO698JG110	7/16"	B	M10	9	60
------------	-------	---	-----	---	----

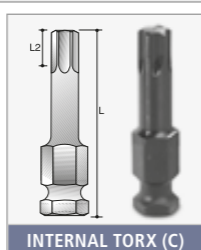

INTERNAL TORX (C)



INTERNAL TORX BITS - 7/16" DRIVE *
Bits fuer Schraubenkopf mit Intern Torx - 7/16" *
Embout Torx interieure - 7/16" *

Type	IMG	Size Gewinde Taille	L2 mm	L mm
------	-----	---------------------	-------	------

Metrical · Metrisch · Métriques

DO697LG130	7/16"	C	T30	3,8	60
DO697LG140	7/16"	C	T40	3,8	60
DO697LG145	7/16"	C	T45	4,3	60
DO697LG150	7/16"	C	T50	5	60
DO697LG155	7/16"	C	T55	5,5	60
DO697LG160	7/16"	C	T60	8	60

* Also available as set DO691121301, see page 50

* Auch erhältlich als Set DO691121301, siehe Seite 50

* Également disponible en set DO691121301, voir page 50



SLEEVE DRIVE SOCKETS

SPINDELGEFÜHRTE STECKSCHLÜSSEL | DOUILLES GUIDÉES

SLEEVE DRIVE SOCKETS

Sleeve Drive Sockets have been developed by Action at the request of Yokota to improve the quality of a joint tightened with impulse wrenches. **Sleeve Drive Sockets minimize play between socket and tool thus reducing "wobble" and stabilizing the torque setting.** The use of Sleeve Drive Sockets is not only of benefit to the actual joint but also reduces vibration to the tool and operator, and reduces noise levels and tool wear.

⚠ CAUTION

Always wear safety goggles when using impact equipment.

Do not hold the socket while in use.

SPINDELGEFÜHRTE KRAFTSTECKSCHLÜSSEL

Steckschlüssel mit Spindelführung wurden auf Wunsch von Yokota durch Action entwickelt, um die Qualität der Schraubverbindung mit Impulsschraubern zu verbessern.

Spindelgeführte Steckschlüssel haben ein minimales Spiel zwischen Steckschlüssel und Antriebsspindel. Dadurch wird das "Wackeln" reduziert und die Drehmomentverluste werden geringer. Der Einsatz von spindelgeführten Steckschlüsseln bietet nicht nur Vorteile für den Schraubfall, sondern vermindert auch den Geräuschpegel und Verschleiß sowie die Vibration der Maschine für den Anwender.

⚠ VORSICHT

Tragen Sie immer eine Sicherheitsbrille bei der Verwendung von Kraftsteckwerkzeug und -geräten. Halten Sie keinen Kraftsteckschlüssel fest, wenn die Maschine in Betrieb ist.

DOUILLES GUIDÉES (SLEEVE DRIVE)

Les douilles Sleeve Drive ont été développées par Action à la demande de Yokota pour améliorer la qualité d'un assemblage vissé avec des visseuses à impulsions. **Les douilles Sleeve Drive minimise le jeu entre la douille et la visseuse réduisant ainsi l'oscillation et stabilisant le couple réglé.** L'utilisation des douilles Sleeve Drive améliore la qualité d'assemblage et réduit aussi la vibration dans la visseuse et dans la main de l'opérateur. On note également une réduction du bruit et de l'usure de l'outil. Des douilles usées sont la cause de perte de puissance, usure du carré d'entraînement de l'outil et augmentation des vibrations et bruits pour l'opérateur. Remplacer vos douilles usées à temps.

⚠ ATTENTION

Toujours porter des lunettes de sécurité en utilisant des outils à chocs. Ne pas tenir la douille pendant l'utilisation.



3/8" DRIVE | ANTRIEB | CARRÉ D'ENTRAÎNEMENT

6-POINT NORMAL 1

6-Kant normal
6-Pans normale

Type	IMG	D1 mm	D2 mm	L mm	L2 mm	
Metrical · Metrisch · Métriques						
DO60910006	6	A	11	19	43	5
DO60910007	7	A	12	19	43	5
DO60910008	8	A	13	19	43	7
DO60910009	9	A	15	19	43	7
DO60910010	10	A	16	19	43	8
DO60910011	11	A	17,5	19	43	9
DO60910012	12	B	19	19	43	9
DO60910013	13	A	20	22	43	9
DO60910014	14	A	21	22	43	9
DO60910015	15	B	22	22	43	11
DO60910016	16	C	24	22	43	11
DO60910017	17	C	25	22	43	11
DO60910018	18	C	26	22	43	11
DO60910019	19	C	27,5	22	43	11
DO60910021	21	C	30	22	43	13

6-POINT NORMAL MAGNETIC 1

6-Kant normal magnetisch
6-Pans normale magnétique

Type	IMG	D1 mm	D2 mm	L mm	L2 mm	
Metrical · Metrisch · Métriques						
DO6091A006	6	A	11	19	43	5
DO6091A007	7	A	12	19	43	5
DO6091A008	8	A	13	19	43	7
DO6091A009	9	A	15	19	43	7
DO6091A010	10	A	16	19	43	8
DO6091A011	11	A	17,5	19	43	9
DO6091A012	12	B	18,5	19	43	9
DO6091A013	13	A	20	22	43	9
DO6091A014	14	A	21	22	43	9
DO6091A015	15	B	22	22	43	11
DO6091A016	16	C	24	22	43	11
DO6091A017	17	C	25	22	43	11
DO6091A018	18	C	26	22	43	11
DO6091A019	19	C	27	22	43	11
DO6091A020	20	C	28	22	43	13
DO6091A021	21	C	30	22	43	13
DO6091A022	22	C	31	22	50	13
DO6091A023	23	C	32	22	50	13
DO6091A024	24	C	34	22	50	13
DO6091A025	25	C	35	22	50	13
DO6091A026	26	C	36	22	50	13
DO6091A027	27	C	38	22	50	13

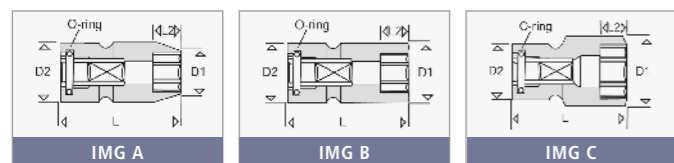

6-POINT LONG 2

6-Kant lang
6-Pans longue

Type	IMG	D1 mm	D2 mm	L mm	L2 mm	
Metrical · Metrisch · Métriques						
DO60913006	6	D	10,5	22	100	4
DO60913008	8	D	12,5	22	100	8
DO60913010	10	D	15	22	100	8
DO60913012	12	D	18	22	100	9
DO60913013	13	D	19	22	100	9
DO60913014	14	D	20	22	100	9
DO60913015	15	D	21	22	100	11
DO60913016	16	D	22,5	22	100	11
DO60913017	17	D	24	22	100	11
DO60914006	6	D	10,5	22	150	4
DO60914008	8	D	12,5	22	150	8
DO60914010	10	D	15	22	150	8
DO60914012	12	D	18	22	150	9
DO60914013	13	D	19	22	150	9
DO60914014	14	D	20	22	150	9
DO60914015	15	D	21	22	150	11
DO60914016	16	D	22,5	22	150	11
DO60914017	17	D	24	22	150	11
DO60915006	6	D	10,5	22	200	4
DO60915008	8	D	12,5	22	200	8
DO60915010	10	D	15	22	200	8
DO60915012	12	D	18	22	200	9
DO60915013	13	D	19	22	200	9
DO60915014	14	D	20	22	200	9
DO60915015	15	D	21	22	200	11
DO60915016	16	D	22,5	22	200	11
DO60915017	17	D	24	22	200	11
DO60915019	19	D	27	22	200	11

6-POINT LONG MAGNETIC 3

6-Kant lang magnetisch
6-Pans longue magnétique

Type	IMG	D1 mm	D2 mm	L mm	L2 mm	
Metrical · Metrisch · Métriques						
DO6091P006	6	D	11	19	100	3
DO6091P007	7	D	12	19	100	3
DO6091P008	8	D	13	19	100	4
DO6091P009	9	D	15	19	100	4
DO6091P010	10	D	16	19	100	4
DO6091P011	11	D	17,5	19	100	5
DO6091P012	12	D	18,5	19	100	5
DO6091P013	13	D	20	22	100	6
DO6091P014	14	D	21	22	100	6
DO6091P015	15	D	22	22	100	7
DO6091P016	16	D	24	22	100	7
DO6091P017	17	D	25	22	100	7
DO6091R008	8	D	13	19	150	4
DO6091R010	10	D	16	19	150	4
DO6091R011	11	D	17,5	19	150	5
DO6091R012	12	D	18,5	19	150	5

3/8" DRIVE | ANTRIEB | CARRÉ D'ENTRAÎNEMENT

6-POINT LONG MAGNETIC (CONTINUED) 1

6-Kant lang magnetisch
6-Pans longue magnétique

Type	IMG	D1 mm	D2 mm	L mm	L2 mm	
Metrical · Metrisch · Métriques						
DO6091R013	13	D	20	22	150	6
DO6091R014	14	D	21	22	150	6
DO6091R015	15	D	22	22	150	7
DO6091R016	16	D	24	22	150	7
DO6091R017	17	D	25	22	150	7
DO6091T009	9	D	15	19	200	4
DO6091T010	10	D	16	19	200	4
DO6091T012	12	D	18,5	19	200	5
DO6091T013	13	D	20	22	200	6
DO6091T014	14	D	21	22	200	6
DO6091T015	15	D	22	22	200	7

6-POINT DEEP MAGNETIC 2

6-Kant tief magnetisch
6-Pans profonde magnétique

Type	IMG	D1 mm	D2 mm	L mm	L2 mm	
Metrical · Metrisch · Métriques						
DO6091Q010	10	A	16	19	100	5
DO6091Q012	12	A	18,5	19	100	6
DO6091Q013	13	A	20	22	100	6
DO6091Q014	14	A	21	22	100	6
DO6091Q016	16	A	24	22	100	7

TORX® INTERNAL 3

Torx® intern
Torx® intérieure

Type	IMG	L1 mm	D2 mm	L mm	-	
DO68811009	T9	E	2	22	75	-
DO68811010	T10	E	2,8	22	75	-
DO68811015	T15	E	2,8	22	75	-
DO68811020	T20	E	2,8	22	75	-
DO68811025	T25	E	3	22	75	-
DO68811027	T27	E	3	22	75	-
DO68811030	T30	E	3,8	22	75	-
DO68811040	T40	E	3,8	22	75	-
DO68811045	T45	E	4,3	22	75	-
DO68811047	T47	E	5	22	75	-
DO68811050	T50	E	5	22	75	-
DO68811055	T55	E	5	22	75	-

Torx® is a trademark of Textron.

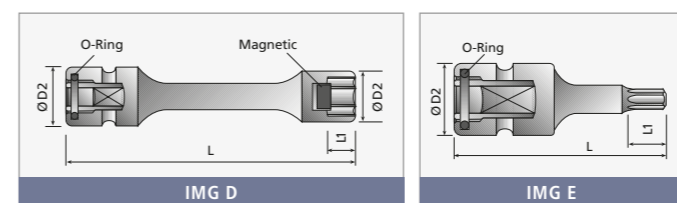

TORX® EXTERNAL 4

Torx® extern
Torx® extérieure

Type	IMG	D1 mm	D2 mm	L mm	L2 mm	
DO66910005	E5	A	8	19	43	4,5
DO66910006	E6	A	9	19	43	5,0
DO66910007	E7	A	9,5	19	43	6,0
DO66910008	E8	A	11	19	43	6,5
DO66910010	E10	A	13	19	43	7,5
DO66910011	E11	A	14	19	43	8,0
DO66910012	E12	A	15,5	19	43	8,5
DO66910014	E14	A	17,5	22	43	10,0
DO66910016	E16	A	18,5	22	43	11,0

Torx® is a trademark of Textron.

HEX DRIVER (INBUS) 5

Außen-6-kant (Inbus)
Empreinte 6-pans (inbus)

Type	IMG	L1 mm	D2 mm	L mm	-	
Metrical · Metrisch · Métriques						
DO68916003	3	E	11	22	75	-
DO68916004	4	E	11	22	75	-
DO68916005	5	E	11	22	75	-
DO68916006	6	E	11	22	75	-
DO68916007	7	E	16	22	75	-
DO68916008	8	E	16	22	75	-
DO68916009	9	E	16	22	75	-
DO68916010	10	E	16	22	75	-
DO68916011	11	E	16	22	75	-
DO68916012	12	E	16	22	75	-
DO68916013	13	E	16	22	75	-
DO68916014	14	E	16	22	75	-
DO68916015	15	E	16	22	75	-
DO68916016	16	E	16	22	75	-

STUD BOLT SETTERS

Stehbolzensetzer
Prise Goujon

Type	Size Gewinde Taille	D1 mm	D2 mm	L mm
DO66A10062	M6 x 1	12,5	22	50
DO66A10083	M8 x 1,25	15	22	50
DO66A10104	M10 x 1,5	17	22	50





1/2" DRIVE | ANTRIEB | CARRÉ D'ENTRAÎNEMENT

6-POINT NORMAL 1

6-Kant normal
6-Pans normale

Type	IMG	D1 mm	D2 mm	L mm	L2 mm
Metrical					
DO60920012	12 A	20	25	52	12
DO60920013	13 A	21	25	52	12
DO60920014	14 A	22,5	25	52	12
DO60920015	15 A	23,7	30	52	12
DO60920016	16 A	25	30	52	12
DO60920017	17 A	26	30	52	12
DO60920018	18 A	27,5	30	52	12
DO60920019	19 A	28,7	30	52	12
DO60920021	21 B	30	30	52	12
DO60920022	22 C	32	30	52	12
DO60920023	23 C	32	30	52	12
DO60920024	24 C	35	30	52	12
DO60920025	25 C	36	30	57	12
DO60920027	27 C	39	30	57	12
DO60920030	30 C	42	30	62	12
DO60920032	32 C	44	30	62	12

6-POINT LONG 2

6-Kant lang
6-Pans longue

Type	IMG	D1 mm	D2 mm	L mm	L2 mm
Metrical · Metrisch · Metriques					
DO60923010	10 D	17	25	100	12
DO60923012	12 D	19,5	25	100	12
DO60923013	13 D	20,5	25	100	12
DO60923014	14 D	21,5	25	100	12
DO60923015	15 D	22,5	25	100	12
DO60923017	17 D	25	25	100	13
DO60923019	19 D	28	25	100	13
Metrical · Metrisch · Metriques					
DO60924010	10 D	17	25	150	12
DO60924012	12 D	19,5	25	150	12
DO60924013	13 D	20,5	25	150	12
DO60924014	14 D	21,5	25	150	12
DO60924015	15 D	22,5	25	150	12
DO60924017	17 D	25	25	150	13
DO60924019	19 D	28	25	150	13
Metrical · Metrisch · Metriques					
DO60925010	10 D	17	25	200	12
DO60925012	12 D	19,5	25	200	12
DO60925013	13 D	20,5	25	200	12
DO60925014	14 D	21,5	25	200	12
DO60925015	15 D	22,5	25	200	12
DO60925017	17 D	25	25	200	13
DO60925019	19 D	28	25	200	13

6-POINT LONG MAGNETIC 3

6-Kant lang magnetisch
6-Pans longue magnétique

Type	IMG	D1 mm	D2 mm	L mm	L2 mm
Metrical · Metrisch · Metriques					
DO6092P010	10 D	17,5	25	100	4
DO6092P011	11 D	18,5	25	100	5
DO6092P012	12 D	20	25	100	5
DO6092P013	13 D	21	25	100	6
DO6092P014	14 D	22,5	25	100	6
DO6092P015	15 D	23,5	30	100	7
DO6092P016	16 D	25	30	100	7
DO6092P017	17 D	26	30	100	7
DO6092P018	18 D	27,5	30	100	8
DO6092P019	19 D	28,5	30	100	8
Metrical · Metrisch · Metriques					
DO6092R010	10 D	17,5	25	150	12
DO6092R011	11 D	18,5	25	150	12
DO6092R012	12 D	20	25	150	12
DO6092R013	13 D	21	25	150	12
DO6092R014	14 D	22,5	25	150	12
DO6092R015	15 D	23,5	30	150	12
DO6092R016	16 D	25	30	150	13
DO6092R017	17 D	26	30	150	13
DO6092R018	18 D	27,5	30	150	13
DO6092R019	19 D	28,5	30	150	13
Metrical · Metrisch · Metriques					
DO6092T010	10 D	17,5	25	200	12
DO6092T011	11 D	18,5	25	200	12
DO6092T012	12 D	20	25	200	12
DO6092T013	13 D	21	25	200	12
DO6092T014	14 D	22,5	25	200	12
DO6092T015	15 D	23,5	30	200	12
DO6092T016	16 D	25	30	200	13
DO6092T017	17 D	26	30	200	13
DO6092T018	18 D	27,5	30	200	13
DO6092T019	19 D	28,5	30	200	13

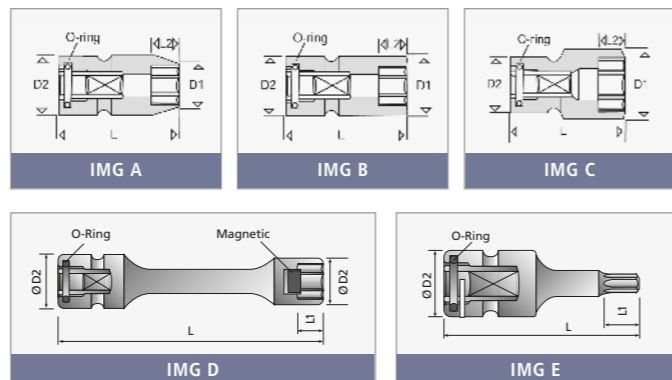

1/2" DRIVE | ANTRIEB | CARRÉ D'ENTRAÎNEMENT

6-POINT NORMAL MAGNETIC 1

6-Kant normal magnetisch
6-Pans normale magnétique

Type	IMG	D1 mm	D2 mm	L mm	L2 mm
Metrical · Metrisch · Metriques					
DO6092A006	6 A	13	25	52	5
DO6092A007	7 A	14	25	52	5
DO6092A008	8 A	15	25	52	7
DO6092A009	9 A	16	25	52	7
DO6092A010	10 A	17,5	25	52	8
DO6092A011	11 A	18,5	25	52	9
DO6092A012	12 A	20	25	52	12
DO6092A013	13 A	21	25	52	12
DO6092A014	14 A	22,5	25	52	12
DO6092A015	15 A	23,5	30	52	12
DO6092A016	16 A	25	30	52	12
DO6092A017	17 A	26	30	52	12
DO6092A018	18 A	27,5	30	52	12
DO6092A019	19 A	28,5	30	52	12
DO6092A020	20 B	30	30	52	12
DO6092A021	21 C	31	30	52	12
DO6092A022	22 C	32	30	52	12
DO6092A023	23 C	34	30	52	12
DO6092A024	24 C	35	30	52	12
DO6092A025	25 C	36	30	57	12
DO6092A026	26 C	38	30	57	12
DO6092A027	27 C	38,5	30	57	12

6-POINT DEEP MAGNETIC 2

6-Kant tief magnetisch
6-Pans profonde magnétique

Type	IMG	D1 mm	D2 mm	L mm	L1 mm
Metrical · Metrisch · Metriques					
DO6092Q010	10 A	17,5	25	100	5
DO6092Q013	13 A	21	25	100	6
DO6092Q016	16 A	25	30	100	7
DO6092Q017	17 A	26	30	100	7
DO6092Q019	19 A	28,5	30	100	8

TORX® EXTERNAL 3

Torx® extern
Torx® extérieure

Type	IMG	D1 mm	D2 mm	L mm	L2 mm
DO66920010	E10 A	14	25	52	7,5
DO66920011	E11 A	15	25	52	8
DO66920012	E12 A	16	25	52	8,5
DO66920014	E14 A	18	25	52	10
DO66920016	E16 A	20	25	52	11
DO66920018	E18 A	22	25	52	12,5
DO66920020	E20 A	25	30	52	14
DO66920022	E22 A	27	30	52	15
DO66920024	E24 A	29	30	52	16,5

Torx® is a trademark of Textron.

TORX® INTERNAL 4

Torx® intern
Torx® intérieure

Type	IMG	L1 mm	D2 mm	L mm	-
DO68821020	T20 E	2,8	25	75	-
DO68821025	T25 E	3	25	75	-
DO68821027	T27 E	3	25	75	-
DO68821030	T30 E	3,8	25	75	-
DO68821040	T40 E	3,8	25	75	-
DO68821045	T45 E	4,3	25	75	-
DO68821047	T47 E	5	25	75	-
DO68821050	T50 E	5	25	75	-
DO68821055	T55 E	5,5	25	75	-
DO68821060	T60 E	8	25	75	-
DO68821070	T70 F	9,4	25	75	-
DO68821080	T80 E	10,5	25	75	-
DO68821090	T90 E	11,8	25	75	-
DO68821100	T100 E	13,1	25	75	-

Torx® is a trademark of Textron.

HEX DRIVER 6-POINT (INBUS) 5

Außen-6-Kant (Inbus)
Empreinte 6-pans (inbus)

Type	IMG	L1 mm	D2 mm	L mm	-
Metrical · Metrisch · Metriques					
DO68925003	3 E	11	25	75	-
DO68925004	4 E	11	25	75	-
DO68925005	5 E	15	25	75	-
DO68925006	6 E	15	25	75	-
DO68925007	7 E	20	25	75	-
DO68925008	8 E	25	25	75	-
DO68925009	9 E	25	25	75	-
DO68925010	10 F	25	25	75	-
DO68925011	11 E	25	25	75	-
DO68925012	12 E	25	25	75	-
DO68925013	13 E	25	25	75	-
DO68925014	14 E	25	25	75	-
DO68925015	15 E	25	25	75	-
DO68925016	16 E	25	25	75	-
DO68925017	17 E	25	25	75	-
DO68925018	18 E	25	25	75	-
DO68925019	19 E	25	25	75	-

STUD BOLT SETTERS

Stehbolzensetzer / Prise Goujon

Type	Size Gewinde Taille	D1 mm	D2 mm	L mm
DO66A21062	M6 x 1	13	25	75
DO66A21083	M8 x 1,25	15	25	75
DO66A21104	M10 x 1,5	17	25	75
DO66A21125	M12 x 1,75	19	25	75
DO66A21146	M14 x 2	22	25	75
DO66A21166	M16 x 2	27	30	75



3/4" DRIVE | ANTRIEB | CARRÉ D'ENTRAÎNEMENT

6-POINT NORMAL 1

6-Kant normal
6-Pans normale

Type	IMG	D1 mm	D2 mm	L mm	L2 mm
------	-----	-------	-------	------	-------

Metrical · Metrisch · Metriques						
DO60940017	17	A	31	44	65	12
DO60940018	18	A	32	44	65	12
DO60940019	19	A	33	44	65	14
DO60940021	21	A	35	44	65	16
DO60940022	22	A	37	44	65	16
DO60940023	23	A	38	44	65	16
DO60940024	24	A	39	44	65	16
DO60940026	26	A	41	44	65	16
DO60940027	27	A	43	44	65	16
DO60940028	28	B	44	44	68	20
DO60940029	29	C	45	44	68	20
DO60940030	30	C	47	44	68	20
DO60940032	32	C	49	44	70	20
DO60940033	33	C	51	44	70	20
DO60940034	34	C	52	44	70	20
DO60940035	35	C	53	44	70	20
DO60940036	36	C	54	44	70	20
DO60940038	38	C	57	44	72	22
DO60940041	41	C	60	44	72	22
DO60940046	46	C	67	54	77	23
DO60940050	50	C	71	54	77	23

6-POINT MAGNETIC 2

6-Kant magnetisch
6-Pans magnétique

Type	IMG	D1 mm	D2 mm	L mm	L2 mm
------	-----	-------	-------	------	-------

Metrical · Metrisch · Metriques						
DO6094A013	13	A	24,5	44	65	12
DO6094A014	14	A	25,5	44	65	12
DO6094A015	15	A	27	44	65	12
DO6094A016	16	A	28	44	65	12
DO6094A017	17	A	30	44	65	12
DO6094A018	18	A	31	44	65	12
DO6094A019	19	A	32	44	65	14
DO6094A020	20	A	34	44	68	14
DO6094A021	21	A	35	44	68	16
DO6094A022	22	A	37	44	68	16
DO6094A023	23	A	38	44	68	16
DO6094A024	24	A	39	44	68	16
DO6094A025	25	A	41	44	69	16
DO6094A026	26	A	42	44	69	16
DO6094A027	27	A	43	44	69	16

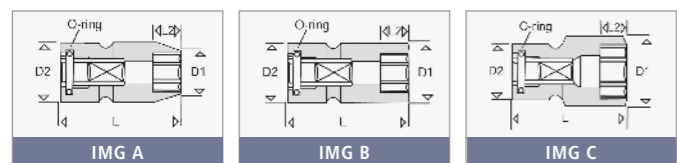

HEX DRIVER 6-POINT (INBUS) 3

Außen-6-Kant (Inbus)
Empreinte 6-pans (inbus)

Type	IMG	D2 mm	L mm	L2 mm
------	-----	-------	------	-------

Metrical · Metrisch · Metriques						
DO68945010	10	E	44	100	20	-
DO68945012	12	E	44	100	20	-
DO68945014	14	E	44	100	20	-
DO68945016	16	E	44	100	20	-
DO68945017	17	E	44	100	20	-
DO68945019	19	E	44	100	20	-
DO68945022	22	E	44	100	20	-
DO68945024	24	E	44	100	20	-
DO68945027	27	E	44	100	20	-
DO68945030	30	E	44	100	20	-
DO68945032	32	E	44	100	20	-
DO68945033	33	E	44	100	20	-
DO68945036	36	E	44	100	20	-
DO68945038	38	E	44	100	20	-

For IMG see previous page | für IMG siehe vorige Seite | Pour IMG, voir page précédente

TORX® EXTERNAL 4

Torx® extern
Torx® extérieure

Type	IMG	D1 mm	D2 mm	L mm	L2 mm
------	-----	-------	-------	------	-------

DO66940018	E18	A	26	44	65	12,5
DO66940020	E20	A	28	44	65	14
DO66940022	E22	A	31	44	65	15
DO66940024	E24	A	33	44	65	16,5

Torx® is a trademark of Textron.

EXTENSIONS

Verlängerungen
Prolongateurs

Type	L mm	D1 mm
------	------	-------

DO64614075	3/8"	75	22
DO64614125	3/8"	125	22
DO64614250	3/8"	250	22
DO64624075	1/2"	75	25
DO64624125	1/2"	125	25
DO64624175	1/2"	175	25
DO64624250	1/2"	250	25
DO64644175	3/4"	175	44
DO64644250	3/4"	250	44
DO64644330	3/4"	330	44



ADAPTORS | VERBINDUNGSTEILE | ADAPTATEURS

QUICKCHANGE ADAPTORS 1

Spindelgeführte Schnellwechselhalter
Adaptateurs a changement rapide, douille guidée

Type	D2 mm	L mm
------	-------	------

Metrical · Metrisch · Metriques					
DO69151112	3/8"	3/8"	19	75	-
DO69151212	3/8"	3/8"	19	100	-
DO69151116	3/8"	1/2"	20	80	-
DO69152112	1/2"	3/8"	25	75	-
DO69152216	1/2"	1/2"	25	100	-
DO69154116	3/4"	1/2"	44	90	-
DO69154324	3/4"	3/4"	44	125	-

BITHOLDERS 2

Spindelgeführte Bithalter
Douilles guidées adaptateurs embout

Type	D2 mm	L mm
------	-------	------

Metrical · Metrisch · Metriques					
DO69111E08	3/8"	1/4"	22	52	-
DO69111E14*	3/8"	7/16"	22	62	-
DO69112E08	1/2"	1/4"	25	60	-
DO69112E14*	1/2"	7/16"	25	70	-
DO69114E14*	3/4"	7/16"	44	80	-

* For Drive bits 7/16" see page 40

ACTION SLEEVE DRIVE POWER SOCKETS GUARANTEE REDUCED VIBRATION!
Action spindelgeführte Kraftsteckschlüssel: reduzierte Vibration!
Action douilles guidées: réduction de la vibration

Action sleeve drive power sockets are supported with an O-ring on the axle of the impulse wrench, giving a tighter fit on the tool.

Action spindelgeführte Kraftsteckschlüssel vermeiden das "Wackeln" vom Kraftsteckschlüssel auf den Antriebsvierkant durch Unterstützung eines Stützringes auf der Antriebs-spindel.

Les douilles Sleeve Drive Prises de courant action manchon en voiture sont pris en charge avec un joint torique sur l'axe de la clé de l'impulsion, ce qui donne un ajustement serré sur l'outil.

SLEEVE DRIVE POWER SOCKETS GUARANTEE:
• Torque improvement
• Reduced vibration
• Reduced noise level
• Reduced wear

SPINDELGEFÜHRTE STECKSCHLÜSSEL GARANTIEREN:
• Verbesserung des Drehmoments
• reduzierte Vibration
• reduzierten Geräuschpegel
• reduzierten Verschleiß

LES DOUILLES SLEEVE DRIVE GARANTIE:
• Amélioration du couple
• Réduction des vibrations
• Niveau de bruit réduit
• Usure réduite

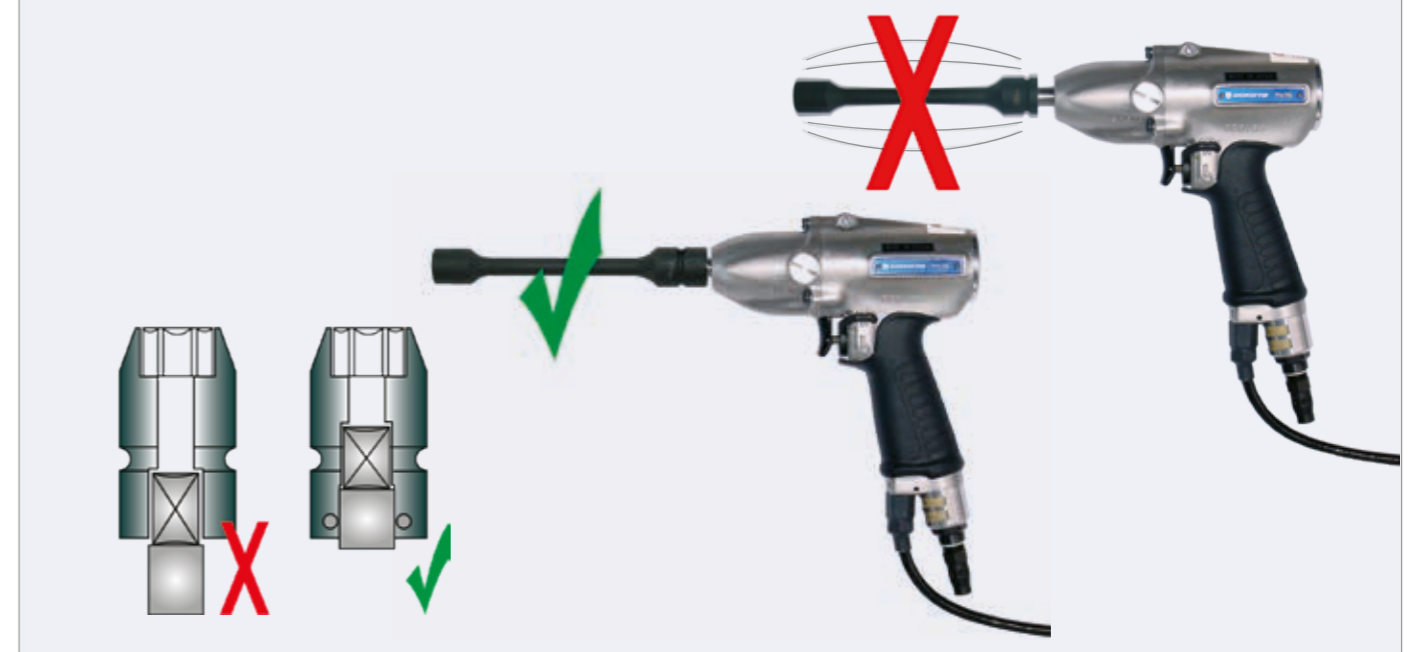

IMPACT SOCKET SETS

SETS STECKSCHLÜSSEL | JEUX DE DOUILLES À CHOC

<p>3/8"</p> 	<p>DO605121301</p> <p>IMPACT SOCKET SET</p> <p>CONTENT: 13 Impact sockets, 6 point, deep 7 - 8 - 9 - 10 - 11 - 12 - 13 - 14 - 15 - 16 - 17 - 18 - 19 mm</p>	<p>SET STECKSCHLÜSSEL</p> <p>INHALT: 13 Kraftsteckschlüssel, 6-Kant, tief 7 - 8 - 9 - 10 - 11 - 12 - 13 - 14 - 15 - 16 - 17 - 18 - 19 mm</p>	<p>JEUX DE DOUILLES</p> <p>COMPREND: 13 Douilles 6-pans, profonde 7 - 8 - 9 - 10 - 11 - 12 - 13 - 14 - 15 - 16 - 17 - 18 - 19 mm</p>
<p>3/8"</p> 	<p>DO611101301</p> <p>IMPACT SOCKET SET</p> <p>CONTENT: 13 Impact sockets, 6 point, thin wall 7 - 8 - 9 - 10 - 11 - 12 - 13 - 14 - 15 - 16 - 17 - 18 - 19 mm <i>AVAILABLE FROM 01-2019</i></p>	<p>SET STECKSCHLÜSSEL</p> <p>INHALT: 13 Kraftsteckschlüssel, 6-Kant, dünnwandig 9 - 10 - 11 - 13 - 14 - 17 - 19 - 22 - 24 - 27 mm <i>LIEFERBAR AB 01-2019</i></p>	<p>JEUX DE DOUILLES</p> <p>COMPREND: 13 Douilles, 6-pans, paroi mince 9 - 10 - 11 - 13 - 14 - 17 - 19 - 22 - 24 - 27 mm <i>DISPONIBLE À PARTIR DE 01-2019</i></p>
<p>1/2"</p> 	<p>DO0012-0-000S</p> <p>IMPACT SOCKET SET</p> <p>CONTENT: 10 Impact sockets, 6 point, normal sizes 9 - 10 - 11 - 13 - 14 - 17 - 19 - 22 - 24 - 27 mm</p>	<p>SET STECKSCHLÜSSEL</p> <p>INHALT: 10 Kraftsteckschlüssel, 6-Kant, normale Ausführung 9 - 10 - 11 - 13 - 14 - 17 - 19 - 22 - 24 - 27 mm</p>	<p>JEUX DE DOUILLES</p> <p>COMPREND: 10 Douilles, 6-pans, normales 9 - 10 - 11 - 13 - 14 - 17 - 19 - 22 - 24 - 27 mm</p>
<p>1/2"</p> 	<p>DO69521093</p> <p>HEX HEAD POWER SOCKETS</p> <p>CONTENT: 9 Hex Head power sockets 4 - 5 - 6 - 8 - 10 - 12 - 14 - 17 - 19 mm</p>	<p>SET AUSSENSECHKANT STECKSCHLÜSSEL</p> <p>INHALT: 9 Inbuskraftsteckschlüssel 4 - 5 - 6 - 8 - 10 - 12 - 14 - 17 - 19 mm</p>	<p>JEUX DE DOUILLES EMPREINTE 6 PANS</p> <p>COMPREND: 9 Douilles 6 pans 4 - 5 - 6 - 8 - 10 - 12 - 14 - 17 - 19 mm</p>
<p>1/2"</p> 	<p>DO691121301</p> <p>QUICK RELEASING CHUCK & HEX DRIVER BIT SET</p> <p>CONTENT: 1 pc. 1/2" Square Drive, 7/16" Hex Quick Releasing Chuck. 6 pcs 11 mm-7/16" Hex Internal Torx bits: T30-T40-T45-T50-T55-T60 6 pcs 11 mm - 7/16" Hex Hexagon Driver: 6-8-10-12-14-17 mm</p>	<p>TORX INTERN + 6-KANT-INBUS-BITS</p> <p>INHALT: 1 Stück 1/2" Schnellwechsler 7/16" Sechskant 6 Stück 7/16" 6-Kant intern Torx Bits: T30-T40-T45-T50-T55-T60 6 Stück 7/16" 6-Kant-inbus-Bits: 6-8-10-12-14-17 mm</p>	<p>JEU DE 13 EMBOUTS À CHOC 7/16" HEX & ADAPTATEUR RAPIDE</p> <p>COMPREND: 1 piece adaptateur rapide 1/2" carré d'entraînement - 7/16" Hexagonale 6 pieces embout 7/16" Hex Internal Torx: T30-T40-T45-T50-T55-T60 6 pieces embout 7/16" Hex Inbus: 6-8-10-12-14-17 mm</p>

IMPACT SOCKET SETS

SETS STECKSCHLÜSSEL | DOUILLES GUIDÉES

<p>1/2"</p> 	<p>DO605222601</p> <p>IMPACT SOCKET SET</p> <p>CONTENT: 26 Impact Sockets, 6 point, deep 10 - 11 - 12 - 13 - 14 - 15 - 16 - 17 - 18 - 19 - 20 - 21 - 22 - 23 - 24 - 25 - 26 - 27 - 28 - 29 - 30 - 32 - 33 - 34 - 35 - 36 mm</p>	<p>SET STECKSCHLÜSSEL</p> <p>INHALT: 26 Kraftsteckschlüssel, 6-Kant, tief 10 - 11 - 12 - 13 - 14 - 15 - 16 - 17 - 18 - 19 - 20 - 21 - 22 - 23 - 24 - 25 - 26 - 27 - 28 - 29 - 30 - 32 - 33 - 34 - 35 - 36 mm</p>	<p>JEUX DE DOUILLES</p> <p>COMPREND: 26 Douilles 6-pans, profonde 10 - 11 - 12 - 13 - 14 - 15 - 16 - 17 - 18 - 19 - 20 - 21 - 22 - 23 - 24 - 25 - 26 - 27 - 28 - 29 - 30 - 32 - 33 - 34 - 35 - 36 mm</p>
<p>1/2"</p> 	<p>DO605202602</p> <p>IMPACT SOCKET SETS</p> <p>CONTENT: 26 Impact sockets, 6 point 10 - 11 - 12 - 13 - 14 - 15 - 16 - 17 - 18 - 19 - 20 - 21 - 22 - 23 - 24 - 25 - 26 - 27 - 28 - 29 - 30 - 32 - 33 - 34 - 35 - 36 mm</p>	<p>SET STECKSCHLÜSSEL</p> <p>INHALT: 26 Kraftsteckschlüssel, 6-Kant 10 - 11 - 12 - 13 - 14 - 15 - 16 - 17 - 18 - 19 - 20 - 21 - 22 - 23 - 24 - 25 - 26 - 27 - 28 - 29 - 30 - 32 - 33 - 34 - 35 - 36 mm</p>	<p>JEUX DE DOUILLES</p> <p>COMPREND: 26 Douilles 6-pans 10 - 11 - 12 - 13 - 14 - 15 - 16 - 17 - 18 - 19 - 20 - 21 - 22 - 23 - 24 - 25 - 26 - 27 - 28 - 29 - 30 - 32 - 33 - 34 - 35 - 36 mm</p>
<p>1/2"</p> 	<p>DO69523108</p> <p>IMPACT SOCKET SET</p> <p>CONTENT: 10 Impact sockets, 6 point, deep 10 - 11 - 13 - 14 - 17 - 19 - 21 - 22 - 24 - 27 mm</p>	<p>SET STECKSCHLÜSSEL</p> <p>INHALT: 10 Kraftsteckschlüssel, 6-Kant, tief 10 - 11 - 13 - 14 - 17 - 19 - 21 - 22 - 24 - 27 mm</p>	<p>JEUX DE DOUILLES</p> <p>COMPREND: 10 Douilles, 6-pans, profonde 10 - 11 - 13 - 14 - 17 - 19 - 21 - 22 - 24 - 27 mm</p>
<p>1/2"</p> 	<p>DO652260701</p> <p>IMPACT SOCKET SET</p> <p>CONTENT: 7 pcs 1/2" dr., impact triple square driver set M5 - M6 - M8 - M10 - M12 - M14 - M16</p>	<p>SET STECKSCHLÜSSEL</p> <p>INHALT: 7 Kraftsteckschlüssel, XZN Bit M5 - M6 - M8 - M10 - M12 - M14 - M16</p>	<p>JEUX DE DOUILLES</p> <p>COMPREND: 7 Douilles, triple carré embout M5 - M6 - M8 - M10 - M12 - M14 - M16</p>

IMPACT SOCKET SETS

SETS STECKSCHLÜSSEL | JEUX DE DOUILLES À CHOC

1/2"	DO61120310	WHEEL NUT IMPACT SOCKET SET EXTRA LONG (130 MM)	SET RADMUTTER- KRAFTSTECKSCHLÜSSEL EXTRA LANG (130 mm)	JEU DE DOUILLES POUR BOULON DE ROUE LEXTRA LONGUES (130 MM)
		CONTENT: 3 Impact sockets with plastic stop and sleeve blue 17 mm - yellow 19 mm - red 21 mm ALSO AVAILABLE AS SINGLE SOCKETS SEE PAGE 20	INHALT: 3 Kraftsteckschlüssel mit Kunststoff Anschlag & Hülse blau 17 mm - gelb 19 mm - rot 21 mm RADMUTTERKRAFTSTECKSCHLÜSSEL SIND AUCH EINZELN LIEFERBAR s.S. 20	COMPREND: 3 Douilles avec butée et manchon plastique bleu 17 mm - jaune 19 mm - rouge 21 mm DOUILLES IMPACT AUSSI DISPONIBLE EN PRISES SIMPLES VOIR P. 20

1/2"	DO611260501	WHEEL NUT IMPACT SOCKET SET LONG (85 MM)	SET RADMUTTER- KRAFTSTECKSCHLÜSSEL LANG (85 mm)	JEU DE DOUILLES POUR BOULON DE ROUE LANG (85 MM)
		CONTENT: 5 impact sockets with plastic stop and sleeve white 15 mm - blue 17 mm - yellow 19 mm - red 21 mm - green 22 mm ALSO AVAILABLE AS SINGLE SOCKETS SEE PAGE 20	CONTENT: 5 Kraftsteckschlüssel mit Kunststoff Anschlag & Hülse weiß 15 mm - blau 17 mm - gelb 19 mm - rot 21 mm - grün 22 mm RADMUTTERKRAFTSTECKSCHLÜSSEL SIND AUCH EINZELN LIEFERBAR s.S. 20	COMPREND: 3 Douilles avec butée et manchon plastique blanc 15 mm - bleu 17 mm - jaune 19 mm - rouge 21 mm - vert 22 mm DOUILLES IMPACT AUSSI DISPONIBLE EN PRISES SIMPLES VOIR P. 20

1/2"	DO0012-0-286	SPECIAL SOCKET SET FOR WHEEL LUG NUT REMOVER	SET STECKSCHLÜSSEL FÜR RADMUTTERSCHLOSS	JEU DE DOUILLES SPECIALES POUR BLOCAGE DE BOULON DE ROUE
		CONTENT: 7 pcs of Lug nut remover sockets 17 - 18,5 - 20 - 21,5 - 23 - 24,5 - 26 mm	INHALT: 7 Kraftsteckschlüssel normale Ausführung 17 - 18,5 - 20 - 21,5 - 23 - 24,5 - 26 mm	COMPREND: 7 Douilles à choc normales 17 - 18,5 - 20 - 21,5 - 23 - 24,5 - 26 mm

APPLICATION WHEEL LUG NUT REMOVERS SOCKETS

Anwendung der Radmutterkraftsteckschlüssel
Application douilles pour depose de boulons de roues

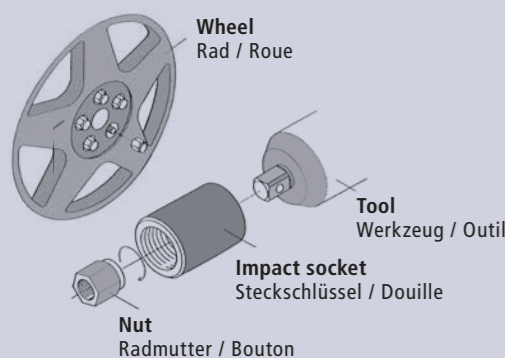

For removal of wheel lock nuts when special key is lost or not supplied upon service and for removal of the wheel nut when hexagon is damaged.

Die Verwendung der Radmutter-schlossentferner ist nur dann erforderlich, wenn der PKW-Fahrer zum Reifendienst geht und den Originalschlüssel vergessen hat. Um doch das Schloss entfernen zu können, werden diese Nüsse verwendet. Beim Aufstecken des Radmutter-schlossentferners beachte man, dass dieser mindestens 3 Gewindegänge tief im Schloss steckt, damit er genug fassen kann.

Pour enlever les boulons anti-ivol lorsque la douille spéciale est perdue ou non fournie et pour enlever les boulons lorsque la tête hexagonale est endommagée.

IMPACT SOCKET SETS

SETS STECKSCHLÜSSEL | JEUX DE DOUILLES À CHOC

3/4"	DO605401001	IMPACT SOCKET SETS	SET STECKSCHLÜSSEL	JEUX DE DOUILLES
		CONTENT: 10 Impact sockets, normal sizes 21 - 22 - 24 - 27 - 30 - 32 - 33 - 36 - 41 - 46 mm	INHALT: 10 Kraftsteckschlüssel, normale Ausführung 21 - 22 - 24 - 27 - 30 - 32 - 33 - 36 - 41 - 46 mm	COMPREND: 10 Douilles, normales 21 - 22 - 24 - 27 - 30 - 32 - 33 - 36 - 41 - 46 mm

3/4"	DO605421001	IMPACT SOCKET SETS	SET STECKSCHLÜSSEL	JEUX DE DOUILLES
		CONTENT: 10 Impact Sockets, 6-Point, deep 21 - 22 - 24 - 27 - 30 - 32 - 33 - 36 - 41 - 46 mm	INHALT: 10 Kraftsteckschlüssel, 6-Kant, tief 21 - 22 - 24 - 27 - 30 - 32 - 33 - 36 - 41 - 46 mm	COMPREND: 10 Douilles 6-pans profonde 21 - 22 - 24 - 27 - 30 - 32 - 33 - 36 - 41 - 46 mm

1"	DO0100-1-007	IMPACT SOCKET SET	SET STECKSCHLÜSSEL	JEUX DE DOUILLES
		CONTENT: 7 Impact sockets, 6-Point, deep 24 - 27 - 30 - 32 - 33 - 36 - 41 mm	INHALT: 7 Kraftsteckschlüssel, 6-Kant, tief 24 - 27 - 30 - 32 - 33 - 36 - 41 mm	COMPREND: 7 Douilles 6-pans profonde 24 - 27 - 30 - 32 - 33 - 36 - 41 mm

DO698800401	IMPACT SOCKET SET MAGNETIC REDUCERS	SET MAGNETISCHE KRATNÜSSE MIT HÜLSEN	ADAPTEURS MAGNÉTIQUE POUR DES DOUILLES À CHOCS
	CONTENT: 4 pcs. Magnetic sleeve insert adaptors 1/4" female x 3/8" male 3/8" female x 1/2" male 1/2" female x 3/4" male 3/4" female x 1" male The magnetic sleeve adaptors allow the temporary use of bigger impact sockets on smaller tools. By means of the magnet, chances of loosing the adaptor are reduced. Especially well suited for the service kit of the travelling mechanic, doing the service to heavy equipment.	INHALT: 4 teiliger Set magnetische reduzierende Verbindungsteile für Kraftsteckschlüssel 1/4" weiblich x 3/8" männlich 3/8" weiblich x 1/2" männlich 1/2" weiblich x 3/4" männlich 3/4" weiblich x 1" männlich Die reduzierende Hülse ermöglicht die Verwendung größerer Kraftsteckschlüssel auf kleinerem Schlagschrauber. Der Magnet sorgt dafür, dass der Adapter den Kraftsteckschlüssel hält. Dieses Set ist ideal für die Toolbox des reisenden Servicetechnikers, bei Wartung und Reparaturen an zum Beispiel schweren Baumaschinen.	COMPREND: Jeu de 4 adaptateurs magnétique pour des douilles à chocs 1/4" femelle x 3/8" mâle 3/8" femelle x 1/2" mâle 1/2" femelle x 3/4" mâle 3/4" femelle x 1" mâle

TORQUE SOCKETS & SPECIALS

TORSIONSKRAFTSTECKSCHLÜSSEL | BARRES LIMITEUR DE COUPLE

1/2"
+ 1"

TORQUE SOCKETS | TORSIONSKRAFTSTECKSCHLÜSSEL | BARRES LIMITEUR DE COUPLE



Type 1/2"	A/F mm	Nm	Length Lange Longuer	Colour Farbe Couleur
DO68122D17	17	75	220	green grün vert
DO68122L17	17	110	220	red rot rouge
DO68122G19	19	90	220	yellow gelb jaune
DO68122L19	19	110	220	blue blau bleu
DO68122M19	19	135	220	grey grau gris
DO68122E21	21	80	220	black schwarz noir
DO68122L21	21	110	220	brown braun brun

Type 1"	A/F mm	Nm	Length Lange Longuer
DO68552U23	23	250	305
DO68552W24	24	350	305
DO68552W27	27	350	305
DO68552Z27	27	450	305
DO68552Y29	29	400	305
DO68552B30	30	550	305
DO68552C30	30	600	305
DO68552A32	32	500	305
DO68552C32	32	600	305
DO68552F32	32	700	305
DO68552A33	33	500	305
DO68552C33	33	600	305
DO68552C36	36	600	305

DO6112P017

SPECIAL

WHEEL NUT SOCKET FOR SPECIAL MERCEDES WHEEL BOLTS (1/2" X 17mm)
Radmutternuss für Radmutter von Mercedes (1/2" x 17 mm)
Boulon de roue Mercedes (1/2" x 17 mm)



Includes rotating plastic sleeve and stop for protecting light alloy wheels.

The Special Impact Socket is suitable for:
Mercedes C-Class / GLK (W204), E-Class (W211, W212, W207), SLK (W172), M-Class (W164, W166), CL-Class (W216), S-Class (W221, W222) and Maybach

Inklusive drehbarer Kunststoffhülse und -anschlag für den Schutz von Leichtmetallrädern.

Diese Sondernuss ist entwickelt für Mercedes C-Klasse / GLK (W204), E-Klasse (W211, W212, W207), SLK (W172), M-Klasse (W164, W166), CL-Klasse (W216), S-Klasse (W221, W222) und Maybach.

Inclus une gaine en plastique pivotante de guidage et d'arrêt pour la protection des jantes en alliage.

Cette douille à choc est spécifique pour les modèles suivants: Mercedes C-Class/GLK (W204), classe E (W211, W212 W207), SLK (W172), M-Class (W164, W166), CL-classe (W216), S-classe (W221, L222) et Maybach.



ACTION

OTHER BROCHURES OF RAMI YOKOTA BV



POWERTOOLS

PRODUCT RANGE TOKU, YOKOTA, RED ROOSTER, ACTION & SMC

Content:
Impact wrenches, Impulse wrenches, Ratchet wrenches, Impact sockets, Screwdrivers, Drills, Grinders & sanders, Hammers, Needlescalers, Saws, Pumps, Air chain hoists, Spring balancers, Air treatment equipment.

AVAILABLE
ENGLISH | GERMAN | FRENCH | DUTCH | POLISH

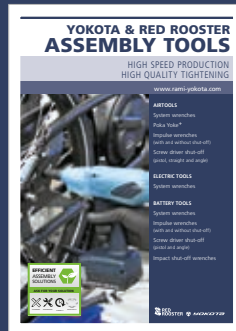

YOKOTA & RED ROOSTER ASSEMBLY TOOLS

HIGH SPEED PRODUCTION
HIGH QUALITY TIGHTENING

Content:
Shut-off screwdrivers & Impulse wrenches (shut-off and non shut-off models), Cordless shut-off screwdrivers & Cordless shut-off impulse wrenches, Sleeve drive sockets & Accessories.

AVAILABLE
ENGLISH | GERMAN



YOKOTA IMPULSE WRENCHES

IMPULSE WRENCHES FOR HIGH SPEED PRODUCTION AND HIGH QUALITY TIGHTENING

Content:
Impulse wrenches, Impulse wrenches with and without shut-off, Cordless impulse wrenches, Poka Yoke+, System wrenches, Electric system wrenches, Battery system wrenches, Sleeve drive sockets

AVAILABLE
ENGLISH | FRENCH | GERMAN



RED ROOSTER AIR CHAIN HOISTS

AIR CHAIN HOISTS 125 KG - 100 TONNES

Content:
Air Chain Hoists 0,125 /100 tonnes, Compact hoists, Mini hoists, Air chain hoists, Trolleys, Explosion proof, Accessories.

AVAILABLE
ENGLISH | FRENCH | GERMAN | SPANISH